



TECHNICAL SUPPORT DOCUMENT

**Air Discharge Permit 24-3638
Air Discharge Permit Application CL-3261**

Issued: March 27, 2024

GATEWAY MART

SWCAA ID – 2802

Prepared By: Clint Lamoreaux
Air Quality Engineer
Southwest Clean Air Agency

TABLE OF CONTENTS

1. FACILITY IDENTIFICATION	1
2. FACILITY DESCRIPTION	1
3. CURRENT PERMITTING ACTION.....	1
4. PROCESS DESCRIPTION	1
5. EQUIPMENT/ACTIVITY IDENTIFICATION	2
6. EMISSIONS DETERMINATION	2
7. REGULATIONS AND EMISSION STANDARDS	4
8. RACT/BACT/BART/LAER/PSD/CAM DETERMINATIONS.....	7
9. AMBIENT IMPACT ANALYSIS	8
10. DISCUSSION OF APPROVAL CONDITIONS	8
11. START-UP AND SHUTDOWN/ALTERNATIVE OPERATING SCENARIOS/POLLUTION PREVENTION.....	9
12. EMISSION MONITORING AND TESTING.....	9
13. FACILITY HISTORY	10
14. PUBLIC INVOLVEMENT OPPORTUNITY	10

Appendix A – CARB Executive Order VR-102-V

ABBREVIATIONS

List of Acronyms

ADP	Air Discharge Permit	NESHAP	National Emission Standards for Hazardous Air Pollutants
AP-42	Compilation of Emission Factors, AP-42, 5th Edition, Volume 1, Stationary Point and Area Sources – published by EPA	NSPS	New Source Performance Standard
BACT	Best available control technology	ORVR	Onboard Refueling Vapor Recovery
BART	Best Available Retrofit Technology	PSD	Prevention of Significant Deterioration
CARB	California Air Resources Board	RACT	Reasonably Available Control Technology
CFR	Code of Federal Regulations	RCW	Revised Code of Washington
EPA	U.S. Environmental Protection Agency	SEPA	State Environmental Policy Act
EU	Emission Unit	Standard	Standard conditions at a temperature of 68°F (20°C) and a pressure of 29.92 in Hg (760 mm Hg)
EVR	Enhanced Vapor Recovery	SWCAA	Southwest Clean Air Agency
LAER	Lowest achievable emission rate	T-BACT	Best Available Control Technology for toxic air pollutants
MACT	Maximum Achievable Control Technologies	WAC	Washington Administrative Code

List of Units and Measures

tpy Tons per year

List of Chemical Symbols, Formulas, and Pollutants

CO.....	Carbon monoxide	PM ₁₀	PM with an aerodynamic diameter 10 µm or less
CO ₂	Carbon dioxide	PM _{2.5}	PM with an aerodynamic diameter 2.5 µm or less
CO _{2e}	Carbon dioxide equivalent	SO ₂	Sulfur dioxide
HAP	Hazardous air pollutant listed pursuant to Section 112 of the Federal Clean Air Act	SO _x	Sulfur oxides
NO _x	Nitrogen oxides	TAP.....	Toxic air pollutant pursuant to Chapter 173-460 WAC
O ₂	Oxygen	VOC.....	Volatile organic compound
PM.....	Particulate Matter with an aerodynamic diameter 100 µm or less		

Terms not otherwise defined have the meaning assigned to them in the referenced regulations or the dictionary definition, as appropriate.

1. FACILITY IDENTIFICATION

Applicant Name: Pioneer Partners Ridgefield, LLC
 Applicant Address: 6929 NW Friberg-Strunk Road
 Camas, WA 98607
 Facility Name: Gateway Mart
 Facility Address: 8307 Pioneer Street
 Ridgefield, WA 98642
 ~ 45°48'58.67"N, 122°41'22.35"W
 SWCAA Identification: 2802
 Contact Person: Taz Khan
 Primary Process: Gasoline dispensing
 SIC/NAICS Code: 5541: Gasoline service stations
 44711: Gas stations with convenience stores (2012 NAICS)
 45711: Gas stations with convenience stores (2022 NAICS)
 Facility Classification: Natural Minor

2. FACILITY DESCRIPTION

This facility will be a retail gasoline dispensing facility associated with a convenience store.

3. CURRENT PERMITTING ACTION

This permitting action is in response to Air Discharge Permit (ADP) application number CL-3261 received February 9, 2024. ADP application CL-3261 requests approval for a new gas station utilizing Stage I enhanced vapor recovery (EVR), low permeation hoses, and enhanced conventional nozzles.

4. PROCESS DESCRIPTION

This facility will receive unleaded gasoline from tanker trucks for storage in two compartments of a single underground storage tank. Diesel fuel will be stored in a third compartment. The gasoline storage tanks will be equipped with two-point vapor balance systems that return gasoline vapors vented from the underground storage tank compartments to the tanker truck during filling (Stage I vapor recovery). Gasoline will be dispensed from 12 multi-product pumps, six of which will also dispense diesel. Vapors displaced from individual motor vehicle gasoline tanks during filling will not be returned to the gasoline storage tank compartments (no Stage II vapor recovery).

<u>Products at Pump</u>	<u>Number of Pumps</u>
Blended gasoline	6
Blended gasoline and diesel	6

5. EQUIPMENT/ACTIVITY IDENTIFICATION

5.a Storage Tanks. The following storage tanks will be utilized at the facility:

Tank	Product	Capacity
1 – 1	Regular Unleaded	14,000 gallons
1 – 2	Super Unleaded	6,000 gallons
1 – 3	Diesel	5,000 gallons

The gasoline storage tanks will be fitted with two-point Stage I enhanced vapor recovery equipment approved by CARB Executive Order VR-102-V "OPW Phase I Vapor Recovery System." The following equipment will be installed:

Component	Make / Model
Drop Tube / Overfill Protection	OPW / 71SO
Fill Adapters ¹	OPW / 61SALP-1020-EVR
Fill Caps	OPW / 634TT-7085-EVR
Vapor Adapters ¹	OPW / 61VSA-1020-EVR
Vapor Caps	OPW / 1711T-7085-EVR
Extractor Assembly	OPW / 233
Float Vent Valve	EBW / 33040011
Spill Bucket	OPW / 1C-2200D (product)
Pressure / Vacuum Valve	OPW / 723V

¹ This is a two point system.

This facility will not utilize Stage II vapor recovery equipment. The following low permeation hoses and enhanced conventional nozzles will be installed:

Component	Make / Model
Nozzles	VST / VST-NV-ND
Hoses and Whip Hoses	VST / V34EC (low permeation)

Location: ~ 45°48'58.67"N, 122°41'22.35"W

5.b. Equipment/Activity Summary.

ID No.	Equipment/Activity	Control Equipment/Measure
1	Retail Gasoline Dispensing Facility	Stage I Vapor Recovery Systems

6. EMISSIONS DETERMINATION

Unless otherwise specified by SWCAA, actual emissions must be determined using the specified input parameter listed for each emission unit and the following hierarchy of methodologies:

(a) Continuous emissions monitoring system (CEMS) data;

- (b) Source emissions test data (EPA reference method). When source emissions test data conflicts with CEMS data for the time period of a source test, source test data must be used;
- (c) Source emissions test data (other test method); and
- (d) Emission factors or methodology provided in this TSD.

Nothing precludes the use, including the exclusive use of any credible evidence or information relevant to identifying or quantifying emissions if such credible evidence provides more accurate identification or quantification of actual emissions than other available information.

- 6.a. Gasoline Vapors. Total potential VOC emissions from the facility were estimated using the following emission factors from the California Air Resources Board December 23, 2013 document "Revised Emission Factors for Gasoline Marketing Operations at California Gasoline Dispensing Facilities":

Emission Source	VOC Emission Factor (lb/1,000 gallons of fuel)
Loading – Stage I Controlled (EVR)	0.150
Breathing – Controlled with P/V Valve	0.092
Uncontrolled Refueling – Stage II uncontrolled (non ORVR Vehicles, no Stage II)	0.84 ¹
Controlled Refueling (ORVR vehicles, no Stage II)	0.151 ²
Spillage (ECO nozzles)	0.240
Hose Permeation (low permeation)	0.009
Total	1.4822

¹ Based on 90% of the gasoline being dispensed to vehicles equipped with carbon canisters (ORVR). The base emission factor, assuming no ORVR vehicles, is 8.400 lb/1,000 gallons. 10% of the vehicles are not equipped with ORVR: 8.4 lb/1,000 gallons * (1-0.90) = 0.84 lb/1,000 gallons.

² This is the amount of vapor released during refueling that is attributable to those vehicles equipped with carbon canisters (ORVR) assuming carbon canisters provide for 98% control. 8.400 lb/1,000 gallons * 90% of gas dispensed to vehicles with ORVR * (2% of vapors not captured by the canister) = 0.151 lb/1,000 gallons.

The above calculations assume that 90% of the fuel is dispensed to vehicles equipped with onboard refueling vapor recovery (ORVR). SWCAA expects this level was met in Clark County in 2020 and was (or will) be met a few years later in Cowlitz, Lewis, Skamania, and Wahkiakum counties.

At a throughput of 5,000,000 gallons of gasoline per year, the facility would emit 3.71 tons of volatile organic compounds. Based on EPA Speciate 3.2 profile number 2455, approximately 50.0% of the total VOC emissions are toxic air pollutants (TAPs) as defined by WAC 173-460 (as in effect August 21, 1998), and approximately 12.9% of the total VOC emissions are federally listed hazardous air pollutants (HAPs). For a throughput of

5,000,000 gallons per year, TAP and HAP emission rates are estimated at 1.85 tons per year, and 0.48 tons per year respectively.

6.b. Emissions Summary

Air Pollutant	Potential to Emit (tpy)	Project Impact (tpy)
NO _x	0	0
CO	0	0
VOC	3.71	3.71
SO ₂	0	0
PM	0	0
PM ₁₀	0	0
PM _{2.5}	0	0
CO ₂ /CO _{2e}	0	0
Toxic Air Pollutants	1.85	1.85
Hazardous Air Pollutants	0.48	0.48

¹ The magnitude of the project impact presented here assumes a gasoline throughput of 5,000,000 gallons per year and that 90% of the fuel is dispensed to vehicles equipped with ORVR. By the end of 2023 SWCAA has estimated that 94% of gasoline dispensed in Clark County will be to ORVR-equipped vehicles.

7. REGULATIONS AND EMISSION STANDARDS

Regulations have been established for the control of emissions of air pollutants to the ambient air. Regulations applicable to the proposed facility that have been used to evaluate the acceptability of the proposed facility and establish emission limits and control requirements include, but are not limited to, the following regulations, codes, or requirements. These items establish maximum emissions limits that could be allowed and are not to be exceeded for new or existing facilities. More stringent limits are established in this ADP consistent with implementation of Best Available Control Technology (BACT):

7.a. Title 40 Code of Federal Regulations (CFR) Part 63.11110 et seq. Subpart CCCCCC "National Emission Standards for Hazardous Air Pollutants for Source Category: Gasoline Dispensing Facilities" establishes emission control, testing, recordkeeping and reporting requirements for new and existing gasoline dispensing facilities. Which requirements apply to a specific facility depends upon the monthly throughput. This facility has a potential throughput of 100,000 gallons per month or more. Facilities with a throughput of 100,000 gallons per month or more must comply with requirements found in Table 1 of Subpart CCCCCC including:

- (1) All vapor connections and lines on the storage tank shall be equipped with closures that seal upon disconnection;

- (2) The vapor line from the gasoline storage tank to the gasoline cargo tank shall be vapor tight;
- (3) The vapor balance system shall be designed such that the pressure in the tank truck does not exceed 18" w.c. pressure or 5.9" w.c. vacuum during product transfer;
- (4) The vapor recovery and product adaptors, and the method of connection with the delivery elbow, shall be designed so as to prevent the over-tightening or loosening of fittings during normal delivery operations;
- (5) Liquid fill connections for all systems shall be equipped with vapor-tight caps;
- (6) Pressure/vacuum vent valves shall be installed on the storage tank vent pipes. The positive pressure setting shall be 2.5" w.c. to 6" w.c. and the negative pressure setting shall be 6" w.c. to 10" w.c. The total leak rate for all pressure/vacuum valves at an affected facility, including connections, shall not exceed 0.17 cubic foot per hour at a pressure of 2.0" w.c. and 0.63 cubic foot per hour at a vacuum of 4" w.c.;
- (7) The vapor balance system shall be capable of meeting the static pressure performance requirement found in Table 1 of Subpart CCCCCC; and
- (8) Each new or existing gasoline storage tank shall be equipped with a dual-point vapor balance system.

In addition, the facility must conduct testing as required by 40 CFR 63.11120, provide notifications as required by 40 CFR 63.11124, and maintain records and report as required by 40 CFR 63.11125 and 63.11126.

EPA Region 10 has indicated that all notifications for this subpart, including initial notifications, should be sent only to SWCAA. The initial notification requirement has been satisfied by submittal of the Air Discharge Permit application.

- 7.b. Title 40 CFR Part 1090 "Regulation of Fuels, Fuel Additives, and Regulated Blendstocks" in section 1090.1550(b) requires that the flow through any nozzle dispensing gasoline into motor vehicles be limited so as not to exceed a maximum value of 10 gallons per minute.
- 7.c. Revised Code of Washington (RCW) 70A.15.2040 empowers any activated air pollution control authority to prepare and develop a comprehensive plan or plans for the prevention, abatement and control of air pollution within its jurisdiction. An air pollution control authority may issue such orders as may be necessary to effectuate the purposes of the Washington Clean Air Act (RCW 70A.15) and enforce the same by all appropriate administrative and judicial proceedings subject to the rights of appeal as provided in Chapter 62, Laws of 1970 ex. sess.
- 7.d. RCW 70A.15.2210 provides for the inclusion of conditions of operation as are reasonably necessary to assure the maintenance of compliance with the applicable ordinances, resolutions, rules and regulations when issuing an ADP for installation and establishment of an air contaminant source.
- 7.e. Washington Administrative Code (WAC) 173-460 "Controls for New Sources of Toxic Air Pollutants" requires Best Available Control Technology for toxic air pollutants (T-BACT), identification and quantification of emissions of toxic air pollutants and demonstration of

- protection of human health and safety from new sources not provided an exemption under WAC 173-460-030. Gasoline dispensing facilities are exempt from the provisions of WAC 173-460.
- 7.f. WAC 173-476 "Ambient Air Quality Standards" establishes ambient air quality standards for PM₁₀, PM_{2.5}, lead, SO₂, NO_x, ozone, and CO in the ambient air, which must not be exceeded.
- 7.g. SWCAA 400-040 "General Standards for Maximum Emissions" requires all new and existing sources and emission units to meet certain performance standards with respect to Reasonably Available Control Technology (RACT), visible emissions, fallout, fugitive emissions, odors, emissions detrimental to persons or property, SO₂, concealment and masking, and fugitive dust.
- 7.h. SWCAA 400-040(3) "Fugitive Emissions" requires that reasonable precautions be taken to prevent the fugitive release of air contaminants to the atmosphere.
- 7.i. SWCAA 400-040(4) "Odors" requires any source which generates odors that may unreasonably interfere with any other property owner's use and enjoyment of their property to use recognized good practice and procedures to reduce these odors to a reasonable minimum.
- 7.j. SWCAA 400-109 "Air Discharge Permit Applications" requires that an ADP application be submitted for all new installations, modifications, changes, or alterations to process and emission control equipment consistent with the definition of "new source." Sources wishing to modify existing permit terms may submit an ADP application to request such changes. An ADP must be issued, or written confirmation of exempt status must be received, before beginning any actual construction, or implementing any other modification, change, or alteration of existing equipment, processes, or permits.
- 7.k. SWCAA 400-110 "New Source Review" requires that SWCAA issue an ADP in response to an ADP application prior to establishment of the new source, emission unit, or modification.
- 7.l. SWCAA 400-113 "Requirements for New Sources in Attainment or Nonclassifiable Areas" requires that no approval to construct or alter an air contaminant source be granted unless it is evidenced that:
- (1) The equipment or technology is designed and will be installed to operate without causing a violation of the applicable emission standards;
 - (2) BACT will be employed for all air contaminants to be emitted by the proposed equipment;
 - (3) The proposed equipment will not cause any ambient air quality standard to be exceeded; and
 - (4) If the proposed equipment or facility will emit any toxic air pollutant regulated under WAC 173-460, the proposed equipment and control measures will meet all the requirements of that Chapter.

7.m. SWCAA 491-040(4) "Gasoline Vapor Control Requirements – Gasoline Dispensing Facilities" establishes the following requirements:

- (1) All gasoline dispensing facilities with an annual gasoline throughput greater than two hundred thousand (200,000) gallons in Clark County and three hundred sixty thousand (360,000) gallons in Cowlitz, Lewis, Skamania and Wahkiakum Counties shall be subject to gasoline Stage I vapor control requirements;
- (2) All gasoline dispensing stations subject to this section shall be equipped with submerged or bottom fill lines and fittings to balance gasoline vapors with the delivery transport tank;
- (3) The owner or operator of a gasoline dispensing facility subject to this section shall not permit the loading of gasoline into a storage tank equipped with vapor recovery equipment from a transport tank equipped with vapor recovery fittings unless Stage I vapor recovery equipment is attached to the transport tank and operated satisfactorily;
- (4) Every retailer and wholesale purchaser-consumer shall equip each pump from which gasoline is dispensed into motor vehicles with a nozzle that dispense fuel at a flow rate not to exceed 10 gallons per minute;
- (5) Stage II vapor recovery equipment compatible with ORVR may be removed from service beginning January 1, 2023 after an Air Discharge Permit has been issued for the modification; and
- (6) New gasoline dispensing facilities (built after February 7, 2020), or existing gasoline dispensing facilities without Stage II vapor recovery, are not required to install Stage II vapor recovery equipment.

8. RACT/BACT/BART/LAER/PSD/CAM DETERMINATIONS

The proposed equipment and control systems incorporate BACT for the types and amounts of air contaminants emitted by the processes as described below:

8.a. Retail Gasoline Dispensing Facility. SWCAA has determined that Best Available Control Technology for the control of gasoline vapors emitted from new gasoline dispensing facilities with a throughput of more than 200,000 gallons per year in Clark County consists of EVR Stage I vapor recovery equipment as tested and approved by CARB, enhanced conventional nozzles (where Stage II is not in place), and low permeation hoses if liquid gasoline is carried against the outermost hose wall.

The applicant proposes to install Stage I enhanced vapor recovery equipment, low permeation hoses, and enhanced conventional nozzles. This configuration meets the requirements of BACT.

8.b. PSD Applicability. Maximum potential emissions from this facility are well below PSD thresholds; therefore, PSD permitting is not required.

- 8.c. Compliance Assurance Monitoring (CAM) Applicability Determination. CAM is not applicable to any emission unit at this source because it is not a major source and is not required to obtain a Part 70 permit.

9. AMBIENT IMPACT ANALYSIS

- 9.a. The retail gasoline dispensing facility equipped with Stage I enhanced vapor recovery systems, ECO nozzles, and low permeation hoses will not cause the ambient air quality standards established by Title 40 Code of Federal Regulations Part 50 (40 CFR 50), "National Primary and Secondary Ambient Air Quality Standards" to be violated.
- 9.b. The retail gasoline dispensing facility equipped with Stage I enhanced vapor recovery systems, ECO nozzles, and low permeation hoses, if properly installed and maintained, can be operated without causing a violation of the applicable emission standards which include the limits established under SWCAA 400-040 "General Standards for Maximum Emissions."
- 9.c. The retail gasoline dispensing facility equipped with Stage I enhanced vapor recovery systems, ECO nozzles, and low permeation hoses will not cause the requirements of WAC 173-476 "Ambient Air Quality Standards" to be violated.

10. DISCUSSION OF APPROVAL CONDITIONS

SWCAA has made a determination to issue ADP 24-3638 in response to ADP application CL-3261. ADP 24-3638 contains approval requirements deemed necessary to assure compliance with applicable regulations and emission standards, as discussed below.

- 10.a. Supersession of Previous Permits. None. This will be a new facility.
- 10.b. Emission Limits. An annual VOC emission limit of 3.71 tons per year was established. This limit is based upon the facility utilizing properly operated Stage I enhanced vapor recovery systems, enhanced conventional nozzles, low permeation hoses, and dispensing 90% of the fuel to ORVR-equipped vehicles, and a gasoline throughput of 5,000,000 gallons per year.
- 10.c. Operational Limits and Requirements. Consistent with SWCAA 400-040(4), the permittee is required to use recognized good practice and procedures to minimize odors that impact other property owners.

The gasoline throughput was limited to 5,000,000 gallons per year. At higher throughputs the facility would be required to increase the frequency of vapor recovery testing.

The remaining requirements are related to proper operation of the Stage I vapor recovery systems, the use of low permeation hoses and enhanced conventional nozzles.

- 10.d. Monitoring and Recordkeeping Requirements. The permittee is required to record each occurrence of maintenance and repairs to vapor recovery equipment so that SWCAA and the permittee can assure that maintenance and repairs are consistent with approved vapor recovery requirements.
- 10.e. Reporting Requirements. Total gasoline throughput and the annual emissions inventory are required to be submitted to SWCAA by January 31st of each year (unless otherwise directed by SWCAA) to demonstrate compliance with the throughput limitation in the permit and allow for the development of a comprehensive emissions inventory. Test results must be reported to SWCAA within 14 days of test completion consistent with CARB and SWCAA reporting requirements.

11. START-UP AND SHUTDOWN/ALTERNATIVE OPERATING SCENARIOS/POLLUTION PREVENTION

- 11.a. Start-up and Shutdown Provisions. Pursuant to SWCAA 400-081 "Start-up and Shutdown," technology-based emission standards and control technology determinations shall take into consideration the physical and operational ability of a source to comply with the applicable standards during start-up or shutdown. Where it is determined that a source is not capable of achieving continuous compliance with an emission standard during start-up or shutdown, SWCAA shall include appropriate emission limitations, operating parameters, or other criteria to regulate performance of the source during start-up or shutdown.

This source is capable of achieving continuous compliance with all applicable requirements; therefore, no start-up or shutdown provisions were included in the ADP.

- 11.b. Alternate Operating Scenarios. SWCAA conducted a review of alternate operating scenarios applicable to equipment affected by this permitting action. The permittee did not propose or identify any applicable alternate operating scenarios. Therefore, none were accommodated by the approval conditions.
- 11.c. Pollution Prevention Measures. SWCAA conducted a review for possible pollution prevention measures outside of the use of Stage I vapor recovery equipment, low permeation hoses, and enhanced conventional nozzles. As indicated in Section 8, Stage II vapor recovery equipment was not necessary to meet the requirements of BACT. No other pollution prevention measures were identified by either the permittee or SWCAA. Therefore, none were accommodated in the approval conditions.

12. EMISSION MONITORING AND TESTING

In accordance with the requirements of SWCAA 491-040(4)(n) that became effective February 7, 2020, testing of each pressure-vacuum vent valve is required every 36 months and Stage I vapor recovery testing is required annually. The pressure-vacuum vent valve testing frequency is consistent with the testing required by 40 CFR 63 Subpart CCCCC. New pressure/vacuum vent

valves are typically tested at the factory, therefore initial testing does not apply to new valves with a factory test. In accordance with SWCAA 491, initial vapor recovery testing is required prior to placing the equipment back into service rather than within 60 days after startup as specified in the applicable CARB Executive Order.

For the static pressure decay test, TP-201.3 does not provide an allowable final pressure for stations without Stage II vapor recovery. Therefore, the allowable final pressure equation from 40 CFR 63 Subpart CCCCCC was included in the permit.

13. FACILITY HISTORY

This will be a new facility.

14. PUBLIC INVOLVEMENT OPPORTUNITY

- 14.a. Public Notice for ADP Application CL-3261. Public notice for ADP application CL-3261 was published on the SWCAA website for a minimum of 15 days, beginning on February 14, 2024.
- 14.b. Public/Applicant Comment for ADP Application CL-3261. SWCAA did not receive specific comments, a comment period request, or any other inquiry from the public or the applicant regarding ADP application CL-3261. Therefore, no public comment period was provided for this permitting action.
- 14.c. State Environmental Policy Act. The City of Ridgefield issued a revised Determination of Nonsignificance on October 19, 2022, for this project (file No. PLZ-22-0116).

Appendix A

CARB Executive Order VR-102-V

Relating to Certification of Vapor Recovery Systems

**OPW Phase I Vapor Recovery System
(Including Remote-Fill and Remote-Additive Configuration)**

**State of California
AIR RESOURCES BOARD**

EXECUTIVE ORDER VR-102-V

Relating to Certification of Vapor Recovery Systems

**OPW Phase I Vapor Recovery System
(Including Remote-Fill and Remote-Additive Configuration)**

WHEREAS, the California Air Resources Board (CARB) has established, pursuant to California Health and Safety Code Sections 25290.1.2, 39600, 39601 and 41954, certification procedures for systems designed for the control of gasoline vapor emissions during the filling of underground gasoline storage tanks, in its Certification Procedure for Vapor Recovery Systems at Gasoline Dispensing Facilities (CP-201), as last amended June 4, 2019, incorporated by reference in Title 17, California Code of Regulations, Section 94011;

WHEREAS, CARB has established, pursuant to California Health and Safety Code Sections 39600, 39601, 39607, and 41954, test procedures for determining the compliance of Phase I vapor recovery systems with emission standards;

WHEREAS, OPW Fueling Components, Inc. (OPW) requested and was granted certification of the OPW Phase I Vapor Recovery System (OPW System) pursuant to CP-201 by Executive Order VR-102-A, first issued on October 10, 2002, and last modified on June 3, 2020, by Executive Order VR-102-U;

WHEREAS, Executive Order G-01-032 delegates to the Chief of the Monitoring and Laboratory Division the authority to certify or approve modifications to certified Phase I and Phase II vapor recovery systems for gasoline dispensing facilities (GDF); and

WHEREAS, I, Catherine Dunwoody, Chief of the Monitoring and Laboratory Division, find that the OPW Phase I Vapor Recovery System (including components that are compatible with E85 fuel blends), as amended to include the components listed above, conforms with all of the requirements set forth in CP 201, and results in a vapor recovery system which is at least 98.0 percent efficient as tested in accordance with test procedure TP-201.1, Volumetric Efficiency for Phase I Systems (July 26, 2012).

NOW THEREFORE, IT IS HEREBY ORDERED that the OPW System is certified to be at least 98.0 percent efficient when installed and maintained as specified herein and in the following exhibits. Exhibit 1 contains a list of the certified components. Exhibit 2 contains the performance standards and specifications, typical installation drawings, and maintenance intervals for the OPW System as installed in a GDF. Exhibit 3 contains the manufacturing specifications. Exhibit 4 contains the manufacturer warranties. Exhibit 5 is the below-grade vaulted tank configuration. Exhibit 6 is the Required Items for Conducting TP-201.1C/TP-201.D on a Remote Fill System.

IT IS FURTHER ORDERED that compliance with the applicable certification requirements, rules, and regulations of the Division of Measurement Standards of the Department of Food and Agriculture, the Office of the State Fire Marshal of the Department of Forestry and Fire Protection, the Division of Occupational Safety and Health of the Department of Industrial Relations, and the Division of Water Quality of the State Water Resources Control Board are made conditions of this certification.

IT IS FURTHER ORDERED that each component manufacturer listed in Exhibit 1 shall provide a warranty for the vapor recovery component(s) to the initial purchaser. The warranty shall be passed on to each subsequent purchaser within the warranty period. The warranty shall include the ongoing compliance with all applicable performance standards and specifications, and shall comply with all warranty requirements in Section 16.5 of CP 201. Manufacturers may specify that the warranty is contingent upon the use of trained installers. The manufacturer's warranty tag, included with each component, shall be provided to the service station owner/operator at the time of installation.

IT IS FURTHER ORDERED that the certified OPW system shall be installed, operated, and maintained in accordance with the CARB Approved Installation, Operation, and Maintenance Manual (Manual). Equipment shall be inspected annually per the procedures identified in the Manual. This inspection requirement shall also apply to systems certified by Executive Orders VR-102-A to U. A copy of this Executive Order and the Manual shall be maintained at each GDF where a certified OPW System is installed.

IT IS FURTHER ORDERED that equipment listed in Exhibit 1, unless exempted, shall be clearly identified by a permanent identification showing the manufacturer's name, model number, and serial number.

IT IS FURTHER ORDERED that any alteration in the equipment, parts, design, installation, or operation of the system provided in the manufacturer's certification application or documents and certified hereby is prohibited and deemed inconsistent with this certification, and is subject to enforcement action, unless the alteration has been submitted in writing pursuant to the process for Executive Order amendments set forth in Section 18 of CP-201 and approved in writing by the CARB Executive Officer or his or her delegate. Any sale, offer for sale, or installation of any system or component without CARB's approval as set forth above is subject to enforcement action.

IT IS FURTHER ORDERED that the following requirements be made a condition of certification. The owner or operator of the OPW system shall conduct and pass the following tests no later than 60 days after startup and at least once every three (3) years after startup testing, using the following test procedures. Shorter time periods may be specified by the District.

- TP-201.3, Determination of 2 Inch WC Static Pressure Performance of Vapor Recovery Systems of Dispensing Facilities (July 26, 2012);
- TP-201.1B, Static Torque of Rotatable Phase I Adaptors (October 8, 2003); and
- Depending on the system configuration, either TP 201.1C, Leak Rate of Drop Tube/Drain Valve Assembly (October 8, 2003) or TP 201.1D, Leak Rate of Drop

Tube Overfill Prevention Devices and Spill Container Drain Valves
(October 8, 2003).

Districts may specify the sequencing of the above tests. Notification of testing and submittal of test results shall be done in accordance with District requirements and pursuant to the policies established by that District. Districts may require the use of alternate test form(s), provided they include the same minimum parameters identified in the datasheet referenced in the test procedure(s). Alternate test procedures, including the most recent versions of test procedures listed above, may be used if determined by the CARB Executive Officer or his or her delegate, in writing, to yield equivalent results. Testing the Pressure/Vacuum (P/V) vent valve will be at the option of the Districts. If P/V vent valve testing is required by the District, the test shall be conducted in accordance with TP-201.1E, Leak Rate and Cracking Pressure of Pressure/Vacuum Vent Valves (October 8, 2003) and Exhibit 2.

IT IS FURTHER ORDERED that the OPW system shall be compatible with gasoline in common use in California at the time of certification, including E85 (85% ethanol/15% gasoline) for specific components listed in Exhibit 1. Any modifications to comply with future California gasoline requirements shall be approved in writing by the CARB Executive Officer or his or her delegate.

IT IS FURTHER ORDERED that GDF installations permitted for dispensing E85 fuel shall be subject to a throughput limitation of 1.2 million gallons per year (100,000 gallons per month).

IT IS FURTHER ORDERED that Executive Order VR-102-U, issued on June 3, 2020, is hereby superseded by this Executive Order. OPW Phase I Vapor Recovery Systems certified under Executive Orders VR-102-A through U may remain in use at existing installations for up to four year after the expiration date of this Executive Order when the certification is not renewed.

IT IS FURTHER ORDERED that this Executive Order shall apply to new installations or major modification of existing Phase I Systems.

IT IS FURTHER ORDERED that this Executive Order shall expire on June 1, 2025.

Executed at Sacramento, California, this 31st day of May 2021.



Catherine Dunwoody, Chief
Monitoring and Laboratory Division

Exhibit 1

OPW Phase I Vapor Recovery System Equipment List

Equipment

Manufacturer/Model Number

(GAS/E85) = Identifies that these components are approved for standard gasoline & E85 fuel blends

Spill Containers¹

Direct Bury Spill Container OPW 1-Series (GAS/E85)
(Figure 1-1)
1-2100 Series
1WW-21XXY-ZEVR -G
1-2200 Series
1WW-22XQZ-G
1-3100 Series
1WW-3VVUTZ-G

1-Series legend

WW A or Blank (Aluminum Cover)
C (cast Iron or Ductile)
SC (Sealable Cover, Cast Aluminum)
PC (Plow Ring Rain Tight Cast Iron Ductile, 1-2000 only)
PSC (Plow Ring Sealable Cover, Cast Aluminum, 1-2200 only)

XX 00 (5 Gal)
X 0 (5 Gal)
Y C (Cast Iron Base)
Blank (composite base)
Z D (drain valve)
P (plug)

VV 1 (5 gallon)
15 (15 gallon)
7 (5 gallon, steel cover)

U 0 (no gauge)
1 (float gauge)
2 (sensor)
3 (float and sensor)
4 (alternate sensor)

T 1 (single wall, cast iron 2100 style base)
2 (double wall)
3 (single wall, cast iron 3100 style base)

Q 0 (flange adaptor, cast iron base)
4 (no flange, 4" thread cast iron base)

G Color (varies)

¹ Drain valves are an optional component for OPW 1-Series product spill containers. If a drain valve is not installed in the OPW 1-Series product spill container, then either an OPW factory installed drain plug or OPW field drain plug kit 1DP-2100 must be installed.

Exhibit 1 (continued)

OPW Phase I Vapor Recovery System Equipment List

<u>Equipment</u>	<u>Manufacturer/Model Number</u>
Spill Containers	Multiport Spill Container OPW 1-Series (GAS/E85) (Figure 1-2) 1-2100SH Series 1-2100Y-ZSH P700 Series P7MM-HHKK P500 Series P5MM-ZHHBJJJ P5MM-NN-HHKK 1-Series legend MM 11 (Composite Base) 11C (Cast Iron Base) 61 (Cast Iron Base) 61C (Cast Iron Base) NN Blank (5 gallon) 15 (15 gallon) HH EVR (Enhanced Vapor Recovery) FL (Fibrelite) KK DV (drain valve) PL (plug) Y C (Cast Iron Base) Blank (composite base) Z D (drain valve) P (plug) JJJ -14 (14" center spacing) BUCKET (16" or larger center spacing)
Replacement Drain Valve Kit	OPW 1DK-2100 (GAS/E85)
Replacement Drain Plug Kit	OPW 1DP-2100 (can be used with any OPW 1-Series Spill Containers) (Figure 1-3 and Figure 1-4)
Dust Caps	OPW 634LPC (product) (GAS/E85) (Figure 1-5) OPW 1711LPC (vapor) (GAS/E85) (Figure 1-6)

Exhibit 1 (continued)

OPW Phase I Vapor Recovery System Equipment List

<u>Equipment</u>	<u>Manufacturer/Model Number</u>
Dust Caps (continued)	OPW 634TT-EVR (product) (GAS/E85) (Figure 1-7)
	OPW 1711T-EVR (vapor) (GAS/E85) (Figure 1-8)
	CompX CSP1-634LPC (Figure 1-9)
	CompX CSP3-1711LPC (vapor) (Figure 1-10)
	CompX CSP2-634LPC (product) (Figure 1-11)
	CompX CSP4-1711LPC (vapor) (Figure 1-12)
Product Adaptor	OPW 61SALP (Figure 1-13)
	OPW 61SALP-MA (GAS/E85) (Figure 1-15)
Vapor Adaptor	OPW 61VSA (Figure 1-14)
	OPW 61VSA-MA (GAS/E85) (Figure 1-16)
Pressure/Vacuum Vent Valve	FFS PV-Zero (Gas/E85) (Figure 1-17)
	OPW 723V (Gas/E85) (Figure 1-18)
	Husky 5885 (Gas/E85) (Figure 1-19)
Jack Screw Kit	OPW 61JSK-4410 (Only used with Composite Base Spill Container) (Figure 1-20)
	OPW 61JSK-44CB (Only used with Cast Iron Base Spill Container) (Figure 1-20)
	OPW 61JSK-4RMT (Only Used on Remote-Fill Configuration) (Figure 1-20)
	OPW 71JSK-44MA (GAS/E85) (Figure 1-21)
	OPW 71JSK-4RMT (GAS/E85) (Figure 1-21)
Face Seal Adaptor	OPW FSA-400
	OPW FSA-400-S (GAS/E85) (Figure 1-22)
Drop Tube	OPW 61T (various lengths)
	OPW 61T-SS (various lengths) (GAS/E85)

Exhibit 1 (continued)

OPW Phase I Vapor Recovery System Equipment List

<u>Equipment</u>	<u>Manufacturer/Model Number</u>
Drop Tube Overfill Prevention Device ²	OPW 61SO (Figure 1-23) OPW 61SOM-412C-EVR (GAS/E85) OPW 71SO (Figure 1-24) OPW 71SO Testable (Figure 1-25) OPW 71SOM-412C (GAS/E85) (Figure 1-26) FFS Defender OPV series 70859X9YZ (Gas/E85 compatible) FFS Defender OPV series 70869X9YZ (Gas/E85 compatible) (Figure 1-27) Defender Series OPV legend: X = upper drop tube length: 1 = 5 feet 2 = 10 feet Y = Tube compatibility: 0 = Gas 2 = Gas/E85 Z = lower drop tube length: 1 = 8 feet 2 = 10 feet
Multiport	OPW (Configuration Only)
Remote Fill	OPW (Configuration Only)
Remote Additive Fill	OPW (Configuration Only)
Tank Bottom Protector²	OPW/Pomeco 6111-1400
Tank Gauge Port Components²	OPW 62M (Cap and Adaptor) (Figure 1-28) OPW 62M-MA (GAS/E85) (Figure 1-29) Morrison Brothers 305XPA1100AKEVR (GAS/E85) (cap & adaptor kit) Morrison Brothers 305-0200AAEVR (GAS/E85) (replacement adaptor) Morrison Brothers 305XP-110ACEVR (GAS/E85) (replacement cap)

² If these components are installed or required by regulations of other agencies, only those components and model numbers specified above shall be installed or used.

Fuel Lock²	Veeder-Root 312020-952 (cap & adaptor) McGard FL1 – Stick Only Fuel Lock (125007) (GAS) (Figure 1-30) McGard FL2 – Stick/Sampling Fuel Lock (125008) (GAS) (Figure 1-30)
Bladder Plug	McGard PSI104
Emergency Vent	Exhibit 5 (for below-grade vaulted tank configuration)

Exhibit 1 (continued)

**Table 1-1
Components Exempt from Identification Requirements**

Component Name	Manufacturer	Model Number
Product Adaptor	OPW	61SALP-MA (GAS/E85)
Vapor Adaptor	OPW	61VSA-MA (GAS/E85)
Replacement Drain Valve	OPW	1DK-2100
Replacement Drain Plug Kit	OPW	1DP-2100
Jack Screw Kit	OPW	61JSK-4410* 61JSK-44CB* 61JSK-4RMT* OPW 71JSK-44MA (GAS/E85) OPW 71JSK-4RMT (GAS/E85)
Tank Gauge Port Component (Cap and Adaptor)	Morrison Brothers	305XPA1100AKEVR (cap & adaptor kit) 305-0200AAEVR (replacement adaptor) 305XP-110ACEVR (replacement cap)
	Veeder-Root	Veeder-Root 312020-952 (cap & adaptor)
	OPW	62M-MA (GAS/E85)
Drop Tube	OPW	61-T 61T-SS (various lengths) (GAS/E85)
Tank Bottom Protector	OPW/Pomeco	6111-1400
Sump / Sump Lids / Spill Container Covers	Varies	Varies
Fuel Lock	McGard	FL1, FL2

* OPW 61JSK MFG date shall be stamped on each jack screw.

Figure 1-1
Direct Bury Spill Container OPW 1-Series (GAS/E85)

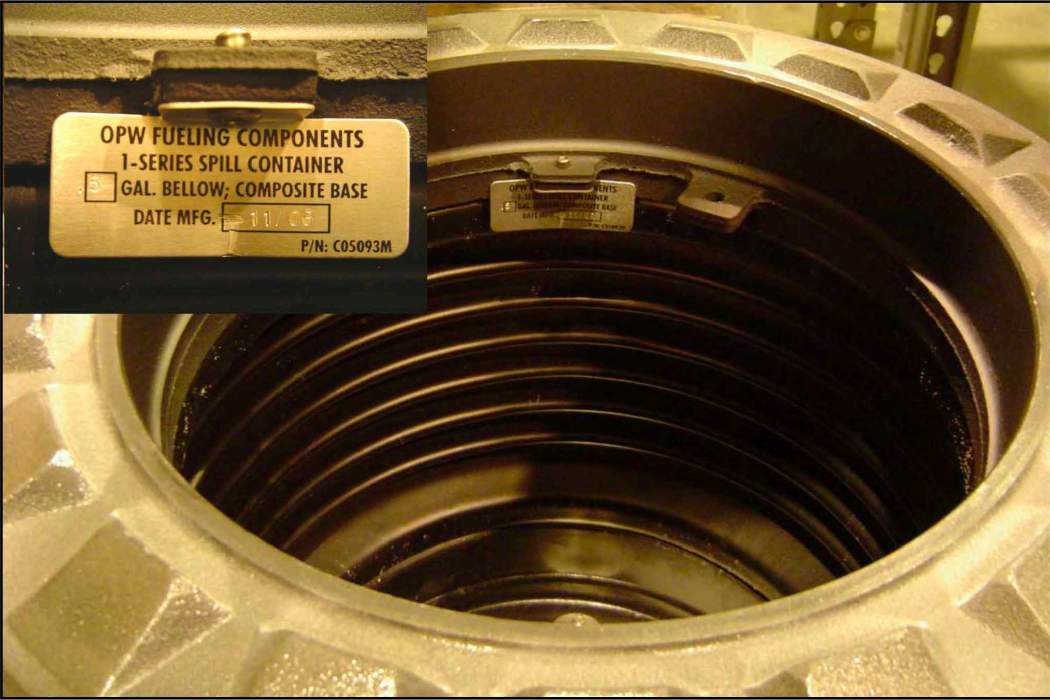

Figure 1-2
Multiport Spill Container OPW 1-Series (GAS/E85)



Figure 1-3
1DP-2100 Drain Plug Kit



Figure 1-4
1DP-2100 Field Installed Drain Plug



Figure 1-5
OPW 634LPC Product Dust Cap



Figure 1-6
OPW 1711LPC Vapor Dust Cap



Figure 1-7
OPW 634-TT-EVR Product Dust Cap

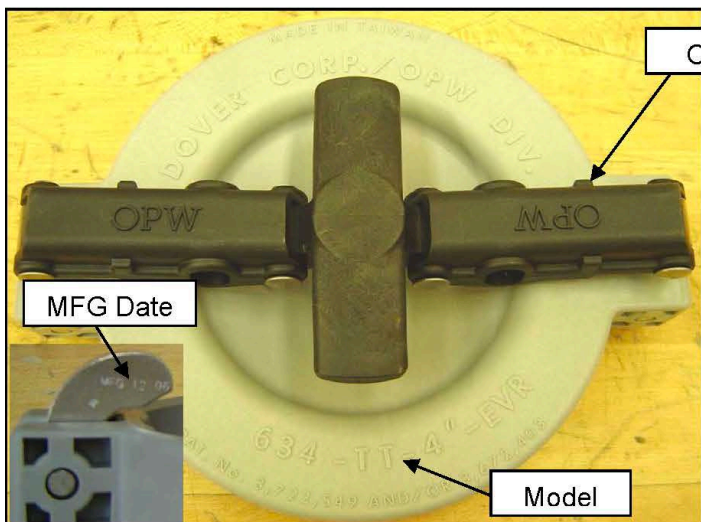

Figure 1-8
OPW 1711-T-EVR Vapor Dust Cap

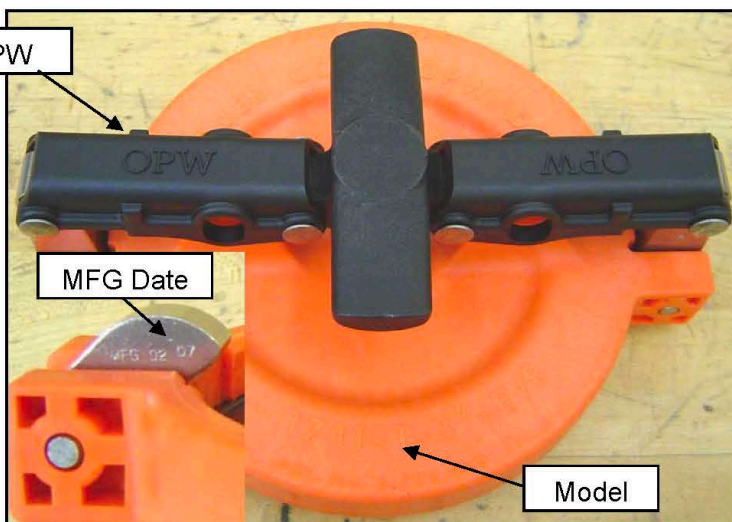

Figure 1-9
CompX CSP1-634LPC Product Dust Cap

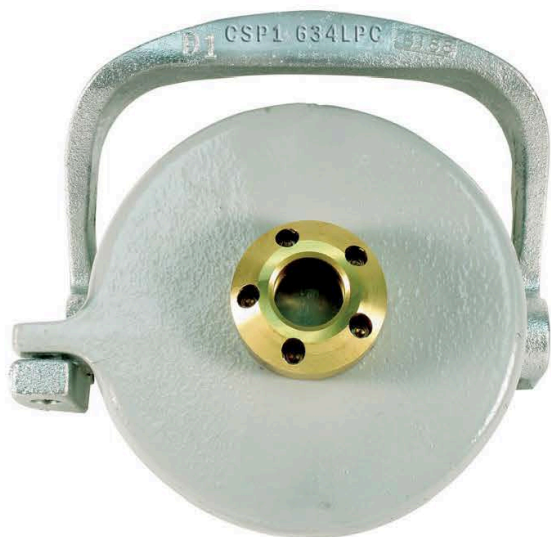

Figure 1-10
CompX CSP3-1711LPC Vapor Dust Cap



CompX Tank Commander Lid
Locks onto CSP1-634LPC and CSP3-1711LPC Dust Caps



Figure 1-11
CompX CSP2-634LPC Product Dust Cap

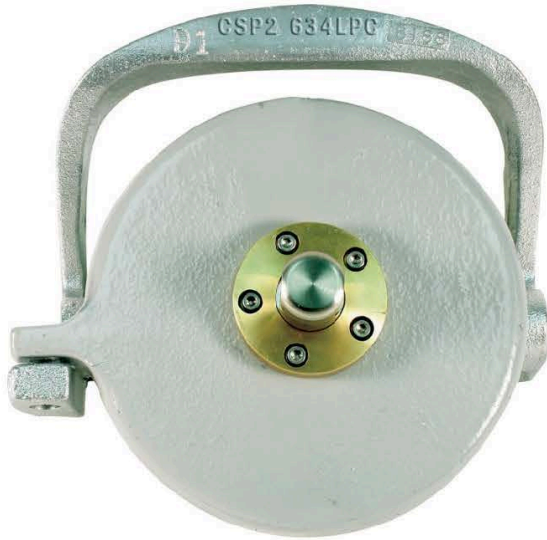

Figure 1-12
CompX CSP4-1711LPC Vapor Dust Cap



CompX Tank Commander Lid
Locks onto CSP2-634LPC and CSP4-1711LPC Dust Caps



Figure 1-13
OPW 61SALP Product Adaptor



Figure 1-14
OPW 61VSA Vapor Adaptor



Figure 1-15
OPW 61SALP-MA Product Adaptor (GAS/E85)



Figure 1-16
OPW 61VSA-MA Vapor Adaptor (GAS/E85)



Figure 1-17
FFS PV-Zero P/V Vent Valve (Gas/E85)
(Model and Serial Number on White Tag)



Figure 1-18
OPW 723V P/V Vent Valve (Gas/E85)

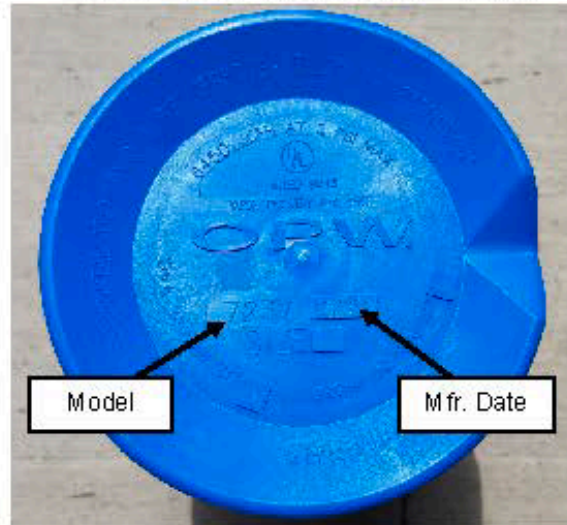

Figure 1-19
Husky 5885 P/V Vent Valve (Gas/E85)
(Husky Name on Bottom Flange)

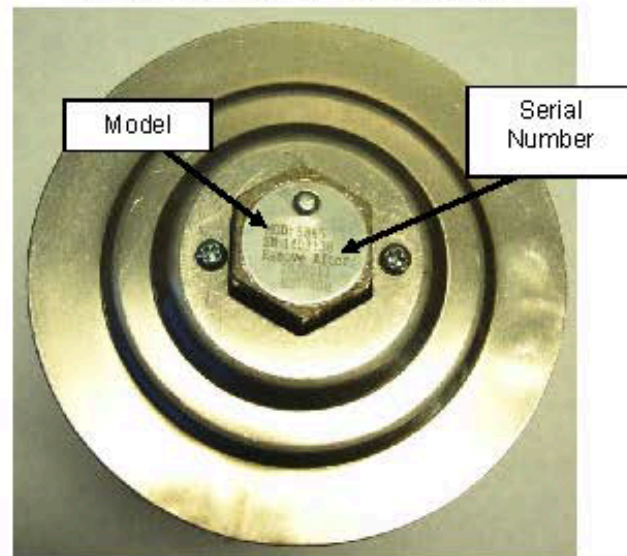

Figure 1-20
OPW 61JSK Jack Screw

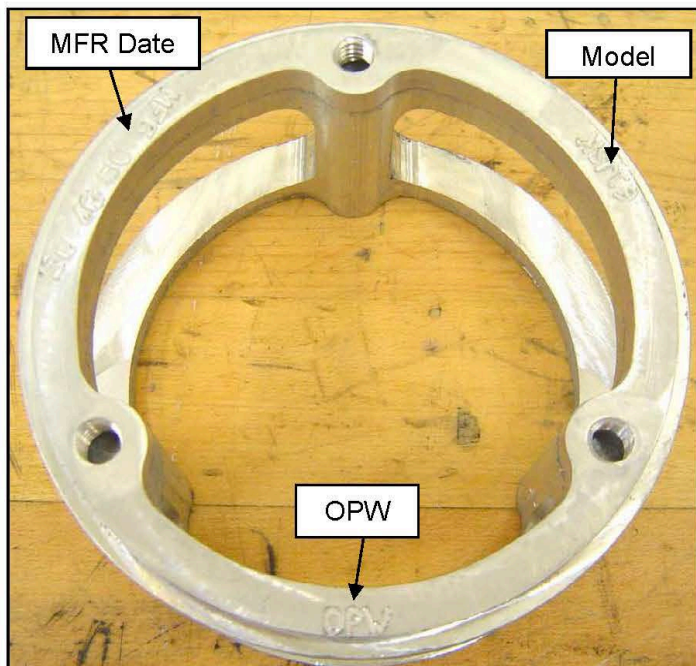

Figure 1-21
71JSK-44MA Jack Screw Kit (GAS/E85)
71JSK-4RMT Jack Screw Kit (GAS/E85)



Figure 1-22
OPW FSA-400-S Face Seal Adaptor (GAS/E85)



Figure 1-23
OPW 61SO Overfill Prevention Devices

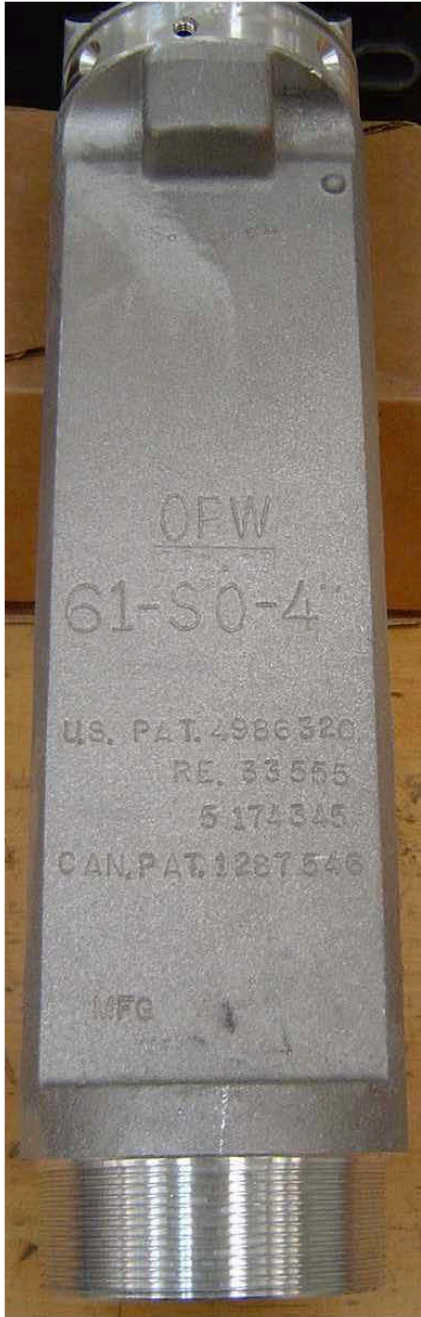

Figure 1-24
OPW 71SO Overfill Prevention Devices

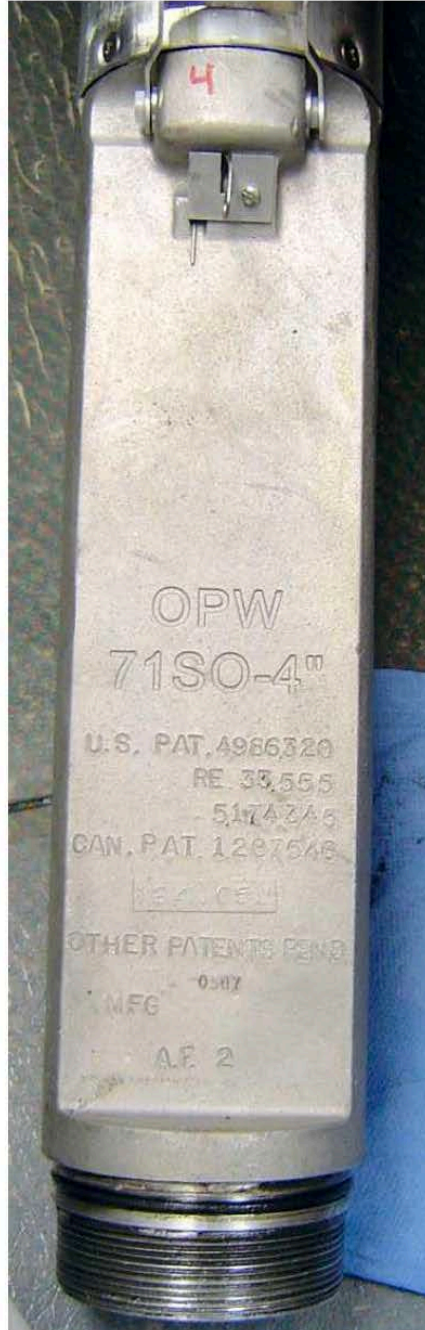

Figure 1-25
71SO Testable Drop Tube



Top View of 71SO Testable
Drop Tube



Figure 1-26
OPW 71SOM-412C Overfill Prevention Device

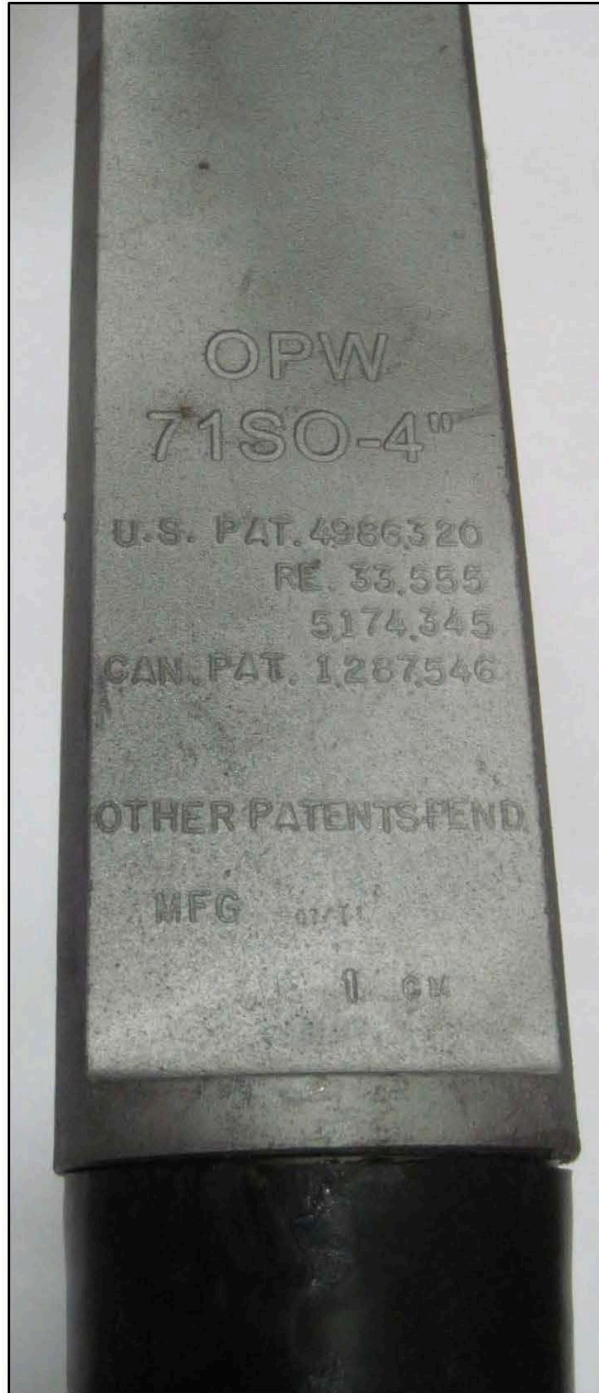

Figure 1-27
Defender OPV series 70859X9YZ (Gas/E85 compatible)



**Defender OPV series
70859X9YZ (Gas/E85)**



Model number

Serial number

**Defender OPV series
70869XYZ (Gas/E85)
KIWA Label**

Figure 1-28
OPW 62M Cap and Adaptor
(Only Cap is identified)



Figure 1-29
OPW 62M-MA Tank Gauge Port Component (GAS/E85)



Figure 1-30
McGard Fuel Lock (FL1 on Left, FL2 on Right)



McGard Fuel Lock Installation Position³

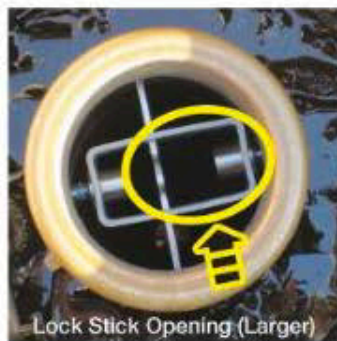

³ Optional component, but if installed this picture shows the correct installation location in the pipe just below the Product Rotatable Adaptor in the drop tube.

This page intentionally left blank.

Exhibit 2

Installation, Maintenance, and Compliance Standards and Specifications

This exhibit contains the installation, maintenance and compliance standards, and specifications applicable to an OPW system installed in a gasoline dispensing facility (GDF).

General Specifications

1. Typical installations of the OPW system are shown in Figures 2-1 and 2-2.
2. Typical installation of the OPW remote fill system is shown in Figures 2-4 and 2-5. Typical installation of the OPW remote additive fill system is shown in Figure 2-6.
3. The OPW system shall be installed, operated, and maintained in accordance with the CARB-Approved Installation, Operation, and Maintenance Manual for the OPW Phase I Vapor Recovery System. Table 2-1 lists the maintenance intervals of OPW system components.
4. Any repair or replacement of system components shall be done in accordance with the CARB-Approved Installation, Operation, and Maintenance Manual for the OPW Phase I Vapor Recovery System.
5. The OPW system shall comply with the applicable performance standards and performance specifications in Table 2-2.
6. Installation, maintenance, and repair of system components, including removal and installation of such components in the course of any required tests, shall be performed by OPW Certified Technicians.

Pressure/Vacuum Vent Valves For Storage Tank Vent Pipes¹

1. No more than three certified pressure/vacuum vent valves (P/V valves) listed in Exhibit 1 shall be installed on any GDF underground storage tank system.
2. Compliance determination of the following P/V valve performance specifications shall be at the option of the districts:
 - a. The leak rate of each P/V valve shall not exceed 0.05 cubic feet per hour (CFH) at 2.00 inches of H₂O positive pressure and 0.21 CFH at 4.00 inches of H₂O negative pressure as determined by TP-201.1E, Leak Rate and Cracking Pressure of Pressure/Vacuum Vent Valves (October 8, 2003).
 - b. The positive pressure setting is 2.5 to 6.0 inches of H₂O and the negative pressure setting is 6.0 to 10.0 inches of H₂O as determined by TP-201.1E Leak Rate and Cracking Pressure of Pressure/Vacuum Vent Valves (October 8, 2003).

¹ The requirement that the vent pipe manifold be installed at a height not less than 12 feet above the grade stated in Executive Orders VR-102-A through VR-102-E is rescinded.

3. Compliance determination of the P/V valve performance specifications in items 2a and 2b for the FFS PV-Zero P/V vent valve shall be conducted with the valve remaining in its installed position on the vent line(s). The PV-Zero portion of the IOM outlines the equipment needed to test the valve in its installed position.
4. A manifold may be installed on the vent pipes to reduce the number of potential leak sources and P/V valves installed. Vent pipe manifolds shall be constructed of steel pipe or an equivalent material that has been listed for use with gasoline. If a material other than steel is used, the GDF operator shall make available, information demonstrating that the material is compatible for use with gasoline. One example of a typical vent pipe manifold is shown in Figure 2-7. This shows only one typical configuration; other manifold configurations may be used. For example, a tee may be located in a different position, or fewer pipes may be connected, or more than one P/V valve may be installed on the manifold.
5. Each P/V valve shall have permanently affixed to it a yellow, gold, or white colored label with black lettering stating the following specifications:

Positive pressure setting: 2.5 to 6.0 inches H₂O
Negative pressure setting: 6.0 to 10.0 inches H₂O
Positive Leakrate: 0.05 CFH at 2.0 inches H₂O
Negative Leakrate: 0.21 CFH at -4.0 inches H₂O

Rotatable Product and Vapor Recovery Adaptors

1. Rotatable product and vapor recovery adaptors shall be capable of at least 360-degree rotation and have an average static torque not to exceed 108 pound-inch (9 pound-foot). Compliance with this requirement shall be demonstrated in accordance with TP-201.1B, Static Torque of Rotatable Phase I Adaptors (October 8, 2003).
2. The vapor adaptor poppet shall not leak when closed. Compliance with this requirement shall be verified by the use of commercial liquid leak detection solution or by bagging, when the vapor containment space of the underground storage tank is subjected to a non-zero gauge pressure. (Note: leak detection solution will detect leaks only when positive gauge pressure exists.)

Vapor Recovery and Product Adaptor Dust Caps

Dust caps with intact gaskets shall be installed on all Phase I tank adaptors.

Product Spill Container Drain Valve

The spill container drain valve, if installed shall be configured to drain liquid directly into the drop tube and shall be isolated from the underground storage tank ullage space. The leak rate of the drain valve shall not exceed 0.17 CFH at 2.00 inches H₂O. Depending on the presence of the drop tube overfill prevention device, compliance with this requirement shall be demonstrated in accordance with either TP-201.1C, Leak Rate of Drop Tube/Drain Valve Assembly (October 8, 2003), or TP-201.1D, Leak Rate of Drop Tube Overfill Prevention Devices and Spill Container Drain Valves (October 8, 2003).

Product Spill Container Drain Plug (Optional)

The product spill container drain plug, either an OPW factory or field installed OPW 1DP-2100 drain plug, shall not leak. The absence of vapor leaks shall be verified with the use of commercial liquid leak detection solution (LDS) when the vapor space of the fill pipe is subjected to a positive gauge pressure.

Drop Tube Overfill Prevention Device

1. The Drop Tube Overfill Prevention Device (overfill device) is designed to restrict the flow of gasoline delivered to the underground storage tank when liquid levels exceed a specified capacity. The overfill device is not a required component of the vapor recovery system, but may be installed as an optional component. Other regulatory requirements may apply.
2. The leak rate of the overfill device shall not exceed 0.17 CFH at 2.00 inches H₂O when tested in accordance with TP-201.1D, Leak Rate of Drop Tube Overfill Prevention Devices and Spill Container Drain Valves (October 8, 2003).
3. For the 71SO Testable overfill prevention device, the threaded test plug shall not leak. The absence of vapor leaks shall be verified with the use of commercial liquid leak detection solution (LDS) when the vapor space of the underground storage tank is subjected to a positive gauge pressure.
4. The discharge opening of the fill pipe must be entirely submerged when the liquid level is six inches above the bottom of the tank as shown in Figure 2-1.

Face Seal Adaptor²

The Face Seal Adaptor shall provide a machined surface on which a gasket can seal and ensures that the seal is not compromised by an improperly cut or improperly finished riser. A Face Seal Adaptor shall be installed on the following required connections. As an option, the adaptor may be installed on other connections.

- a. Product Spill Container (required)
- b. Tank Gauging Components (required)
- c. Vapor Recovery Spill Container (optional)
- d. Rotatable Adaptors (optional)

Double Fill Configuration

OPW Double Fill Configuration shall be allowed for installation provided that no more than two fill and two vapor return points are installed on any single underground storage tank and that no offset of the vapor recovery riser pipe is installed. An example of an OPW Dual Fill configuration is shown in Figure 2-3.

² Face Seal Adaptor is not required with double wall 1-3100 and 1-2200 series spill containers.

Remote Fill Configuration

1. No liquid condensate traps are allowed with this configuration.
2. For new installations and existing installations undergoing major modifications, the Phase I vapor return piping from the remote vapor access point to the tank shall have a minimum slope of one-eighth (1/8) inch per foot of pipe run. A slope of one-quarter (1/4) inch or more per foot of pipe run is recommended wherever feasible. For existing installations, the Phase I vapor return piping from the remote vapor access point to the tank shall be installed so that any liquid in the line will drain toward the storage tank.
3. For new installations and existing installations undergoing major modifications, the Phase I vapor return piping from the remote vapor access point to the tank shall have a minimum nominal internal diameter of four inches (4" ID). For existing installations, the Phase I vapor return piping from the remote vapor access point to the tank shall have a minimum nominal internal diameter of three inches (3" ID).
4. The submerged fill pipe riser shall be fitted with a 4" pipe cap or if the submerged fill pipe riser is used as a port to manually gauge the fuel level in the UST (sticking port), a 62M cap and adaptor, as specified in Exhibit 1, shall be installed.

Remote Additive Fill Configuration

Any gasoline additive can be used only if prior to use, OPW provides a written response that the additive is compatible with the OPW Phase I system. OPW can be contacted at:

www.opwglobal.com/TechSupport/TechnicalServiceAssistance.aspx

Vapor Recovery Riser Offset

1. The vapor recovery tank riser may be offset from the tank connection to the vapor recovery Spill Container provided that the maximum horizontal distance (offset distance) does not exceed 20 inches. One example of an offset is shown in Figure 2-8.
2. The vapor recovery riser shall be offset up to 20 inches horizontal distance with use of commercially available, 4 inch diameter steel pipe fittings.

Tank Gauge Port Components

The tank gauge adaptor and cap are paired. Therefore, an adaptor manufactured by one company shall be used only with a cap manufactured by the same company.

Warranty

Each manufacturer listed in Exhibit 1 shall include a warranty tag with the certified component(s). The manufacturer warranty tag, included with each component, shall be provided to the service station owner/operator at the time of installation.

Connections and Fittings

All connections and fittings not specifically certified with an allowable leak rate shall not leak. The absence of vapor leaks shall be verified with the use of commercial liquid leak detection solution (LDS) or by bagging, when the vapor containment space of the underground storage tank is subjected to a non-zero gauge pressure. (Note: leak detection solution will detect leaks only when positive gauge pressure exists).

Maintenance Records

Each GDF operator or owner shall keep records of maintenance performed at the facility. Such record shall be maintained on site or in accordance with district requirements or policies. Additional information may be required in accordance with district requirements or policies. The records shall include the maintenance or test date, repair date to correct test failure, maintenance or test performed, affiliation, telephone number, name and Certified Technician Number of individual conducting maintenance or test. An example of a Phase I Maintenance Record is shown in Figure 2-9.

**Table 2-1
Maintenance Intervals for System Components³
(Reference Exhibit 1 for list of certified components)**

Manufacturer	Component	Maintenance Interval
OPW	Pressure/Vacuum Vent Valve	Annual
Husky	Pressure/Vacuum Vent Valve	Annual
FFS	Pressure/Vacuum Vent Valve	Annual
All Manufacturers	Tank Gauge Components	Annual
OPW	Dust Caps (all models)	Annual
CompX	Dust Caps (all models)	Annual
OPW	61-T Straight Drop Tube	Annual
OPW	Rotatable Phase I Adaptors	Annual
All Manufacturers	Drop Tube Overfill Prevention Valve	Annual
OPW	Spill Containers (all models)	Annual

**Table 2-2
Gasoline Dispensing Facility Compliance Standards and Specifications**

Component / System	Test Method	Standard or Specification
Rotatable Phase I Adaptors	TP-201.1B	Minimum, 360-degree rotation Maximum, 108 pound-inch average static torque
Overfill Prevention Device	TP-201.1D	≤0.17 CFH at 2.00 in H ₂ O
Spill Container Drain Valve	TP-201.1C or TP-201.1D	≤0.17 CFH at 2.00 in H ₂ O
P/V Valve ⁴	TP-201.1E	Positive pressure setting: 2.5 to 6.0 in H ₂ O Negative pressure setting: 6.0 to 10.0 in H ₂ O Positive Leakrate: 0.05 CFH at 2.0 in H ₂ O Negative Leakrate: 0.21 CFH at -4.0 in H ₂ O
Gasoline Dispensing Facility	TP-201.3	As specified in TP-201.3 and/or CP-201
Connections and fittings certified without an allowable leak rate	Leak Detection Solution or Bagging	No leaks

³ Maintenance must be conducted within the interval specified from the date of installation and at least within the specified interval thereafter.

⁴ Compliance determination is at the option of the district.

**Figure 2-1
Typical Product Installation Using OPW System⁵**

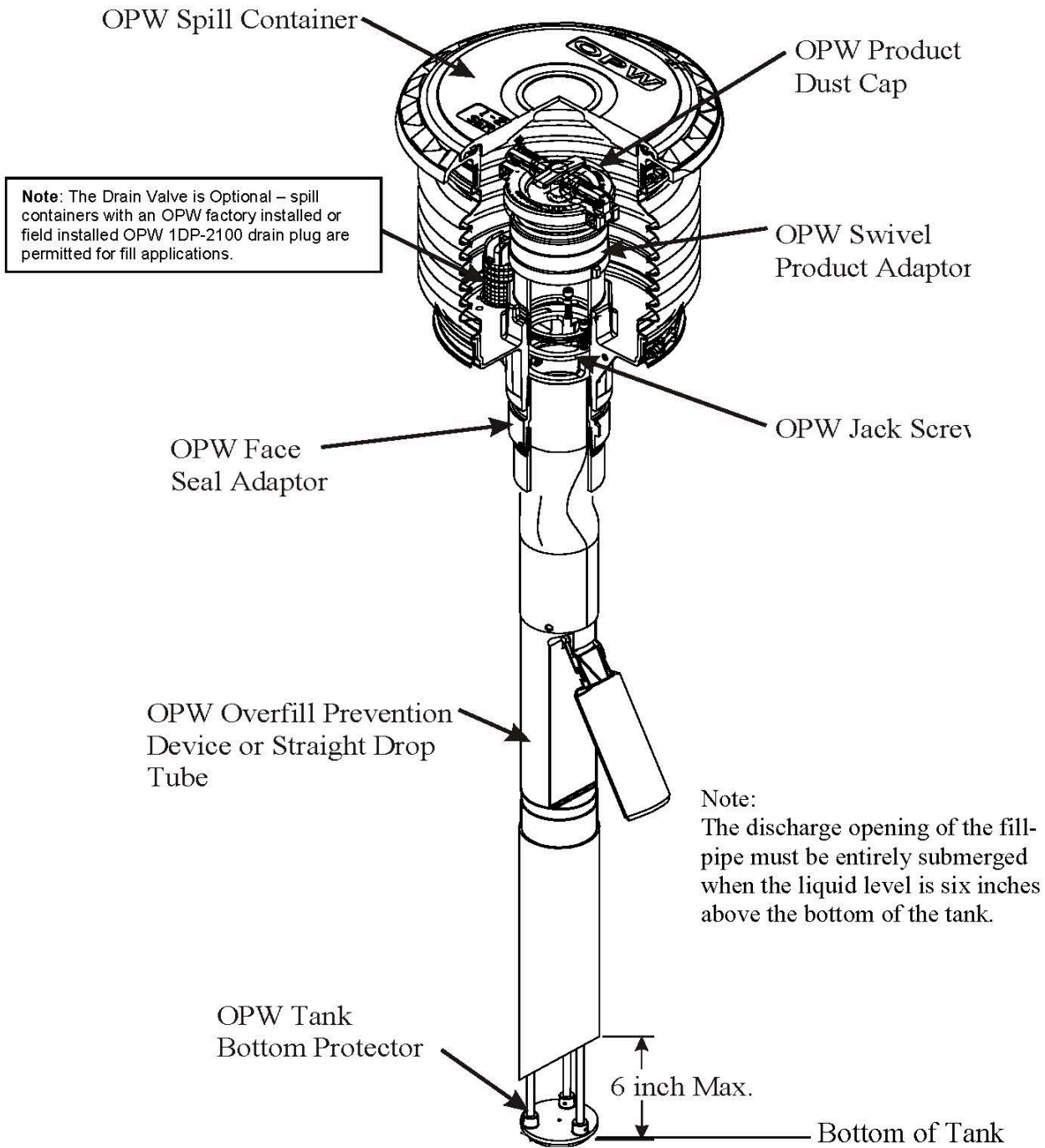

⁵ McGard FL1 or FL2 Fuel Lock (Optional - Not Pictured), if installed, would be positioned inside the riser seal (or pipe nipple) below the rotatable adaptor.

Figure 2-2
Typical Product Installation Using OPW Spill Bucket and
Defender Series OPV Drop Tube Overfill Prevention Device⁶

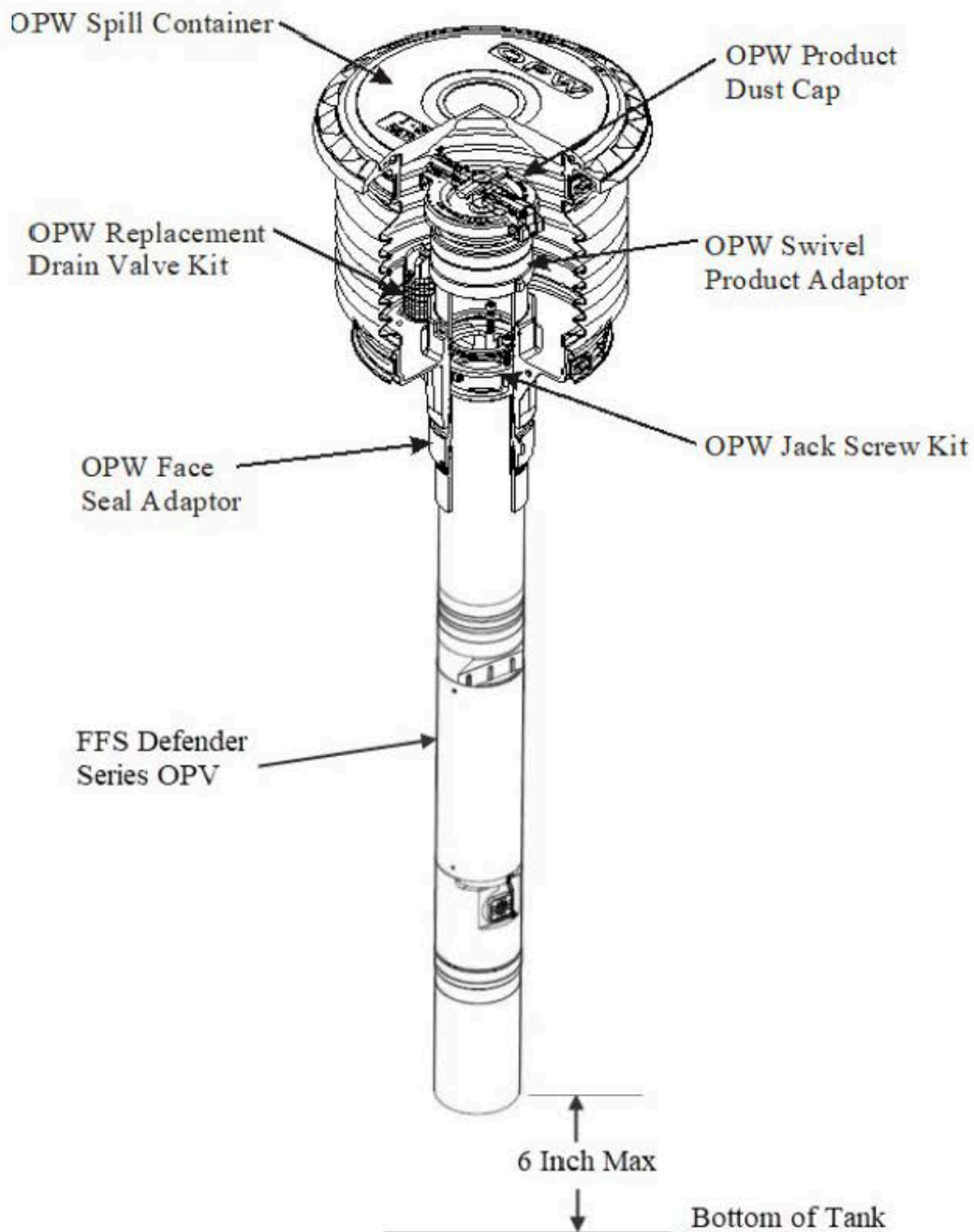

⁶ McGard FL1 or FL2 Fuel Lock (Optional - Not Pictured), if installed, would be positioned inside the riser seal (or pipe nipple) below the rotatable adaptor.

Figure 2-3
Typical Vapor Installation Using OPW System

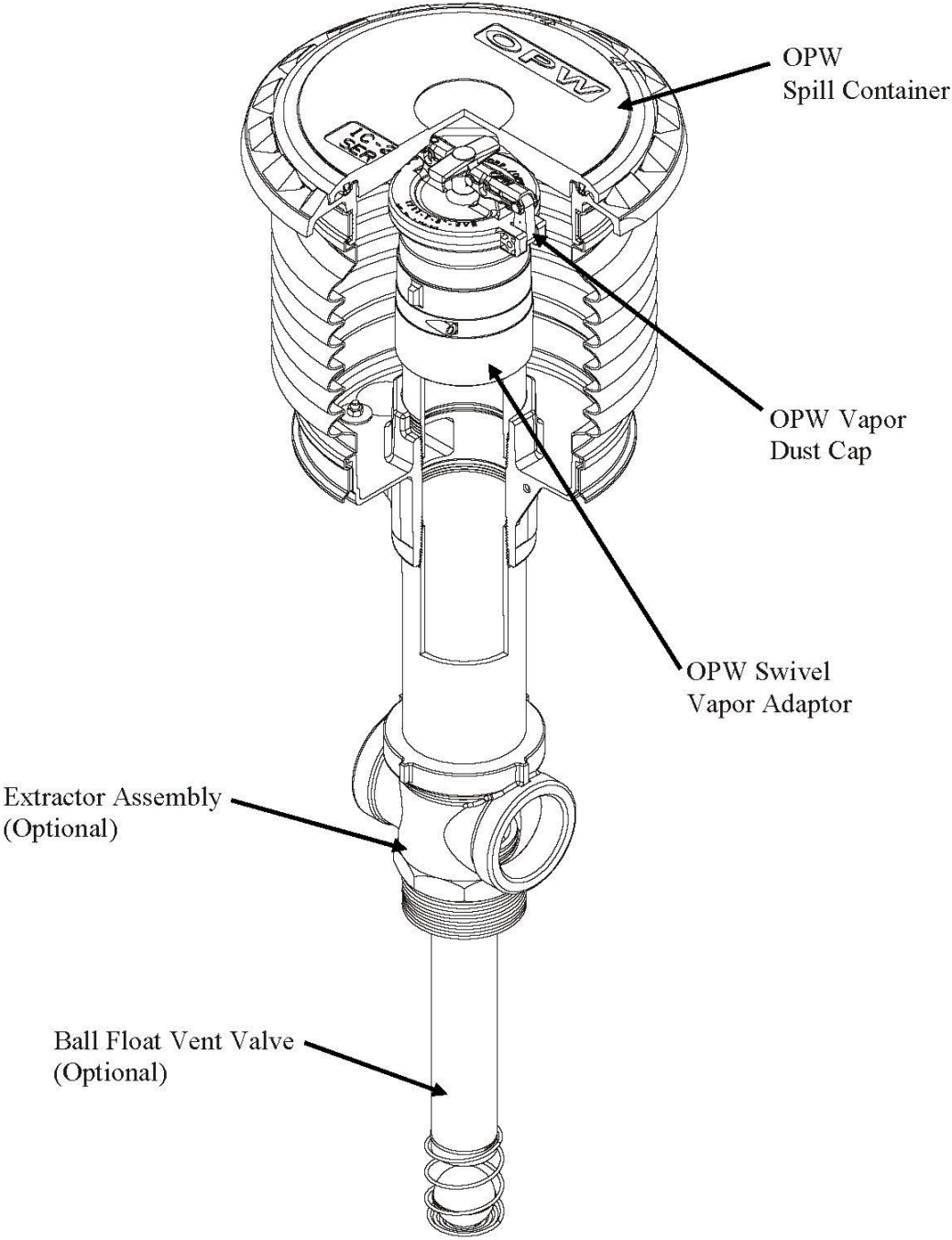

Figure 2-4
Typical OPW/POMEKO Double Fill Configuration

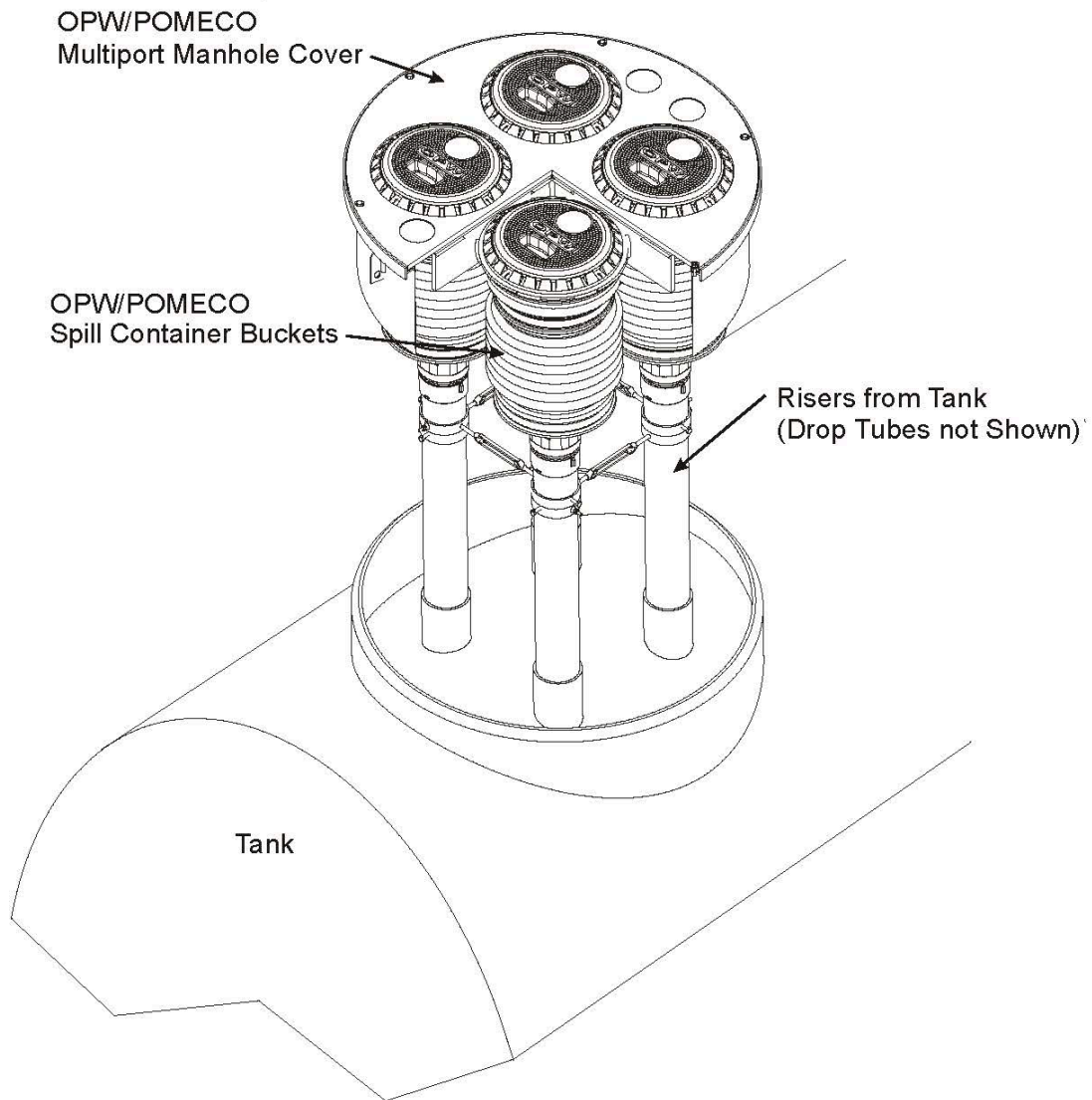

Figure 2-5
Typical Remote-Fill Access Point Configuration

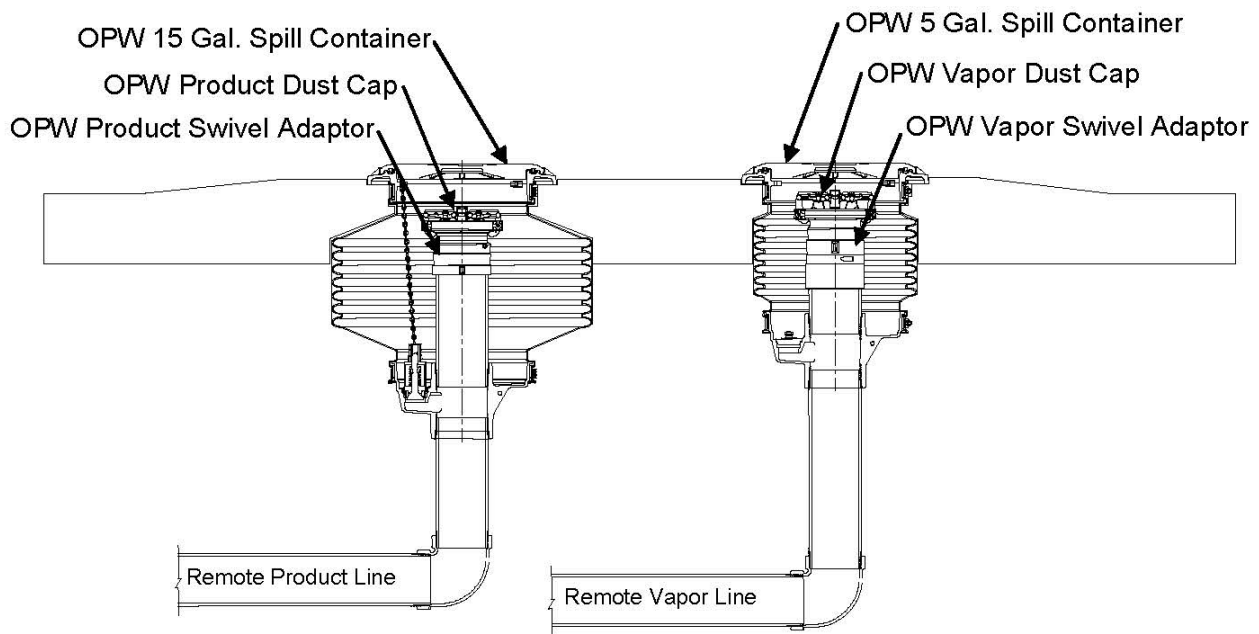

Figure 2-6
Typical Remote-Fill Tank Top Configuration

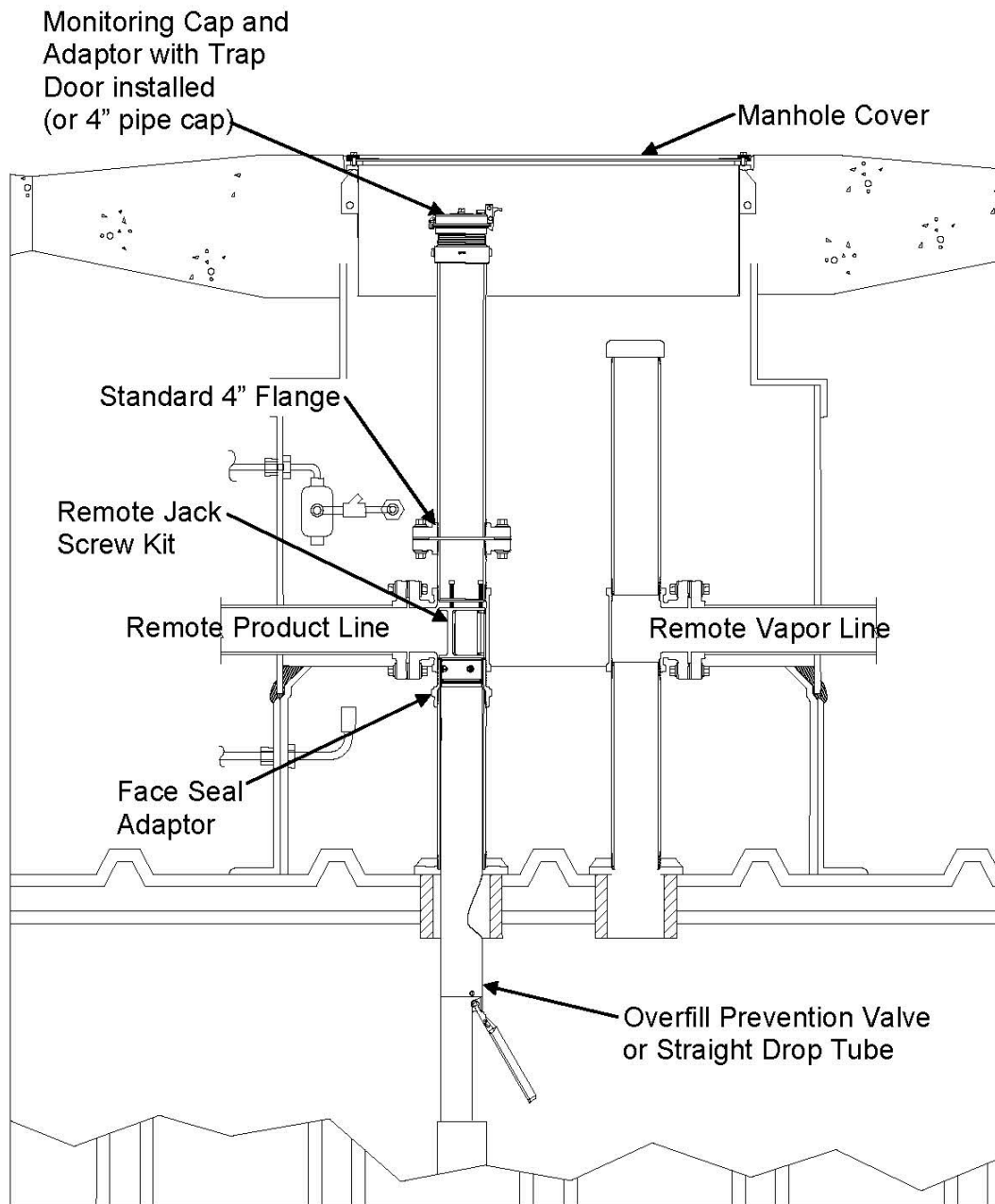
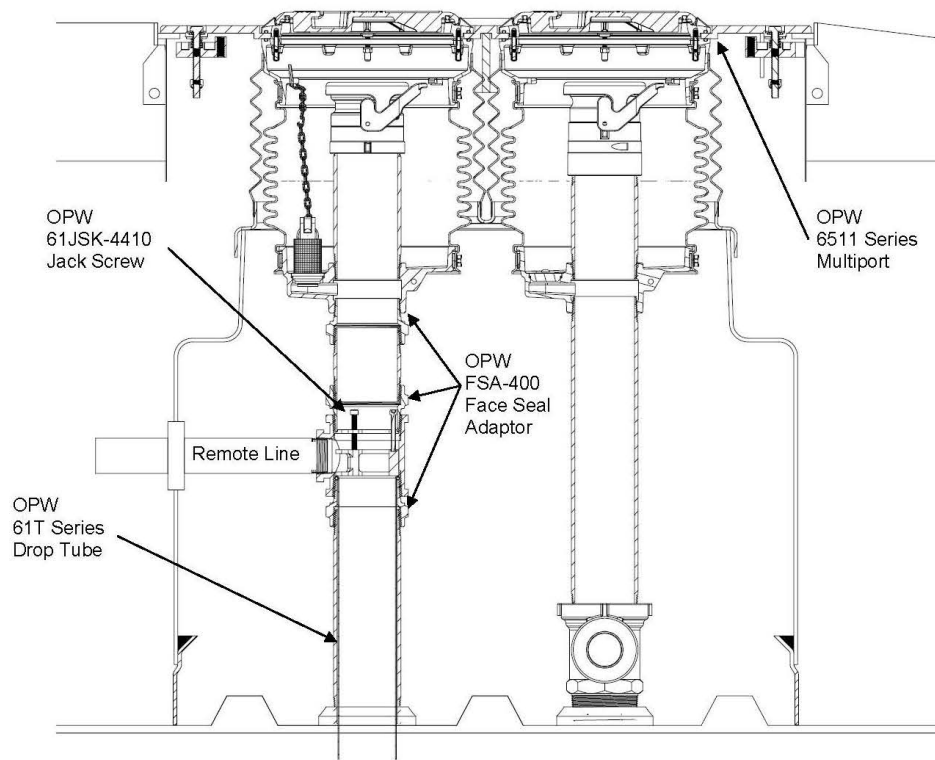
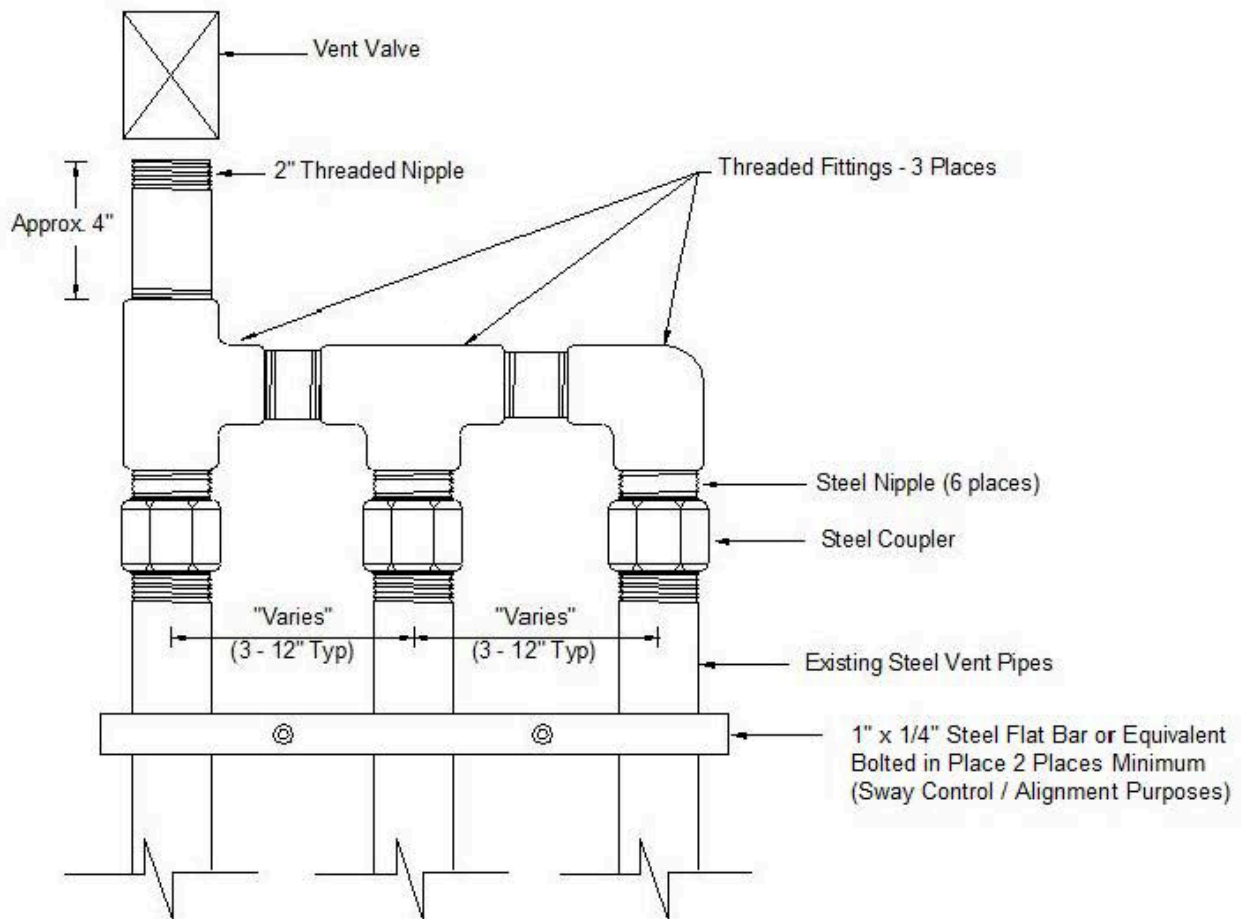

Figure 2-7
Typical Remote Additive Fill Configuration

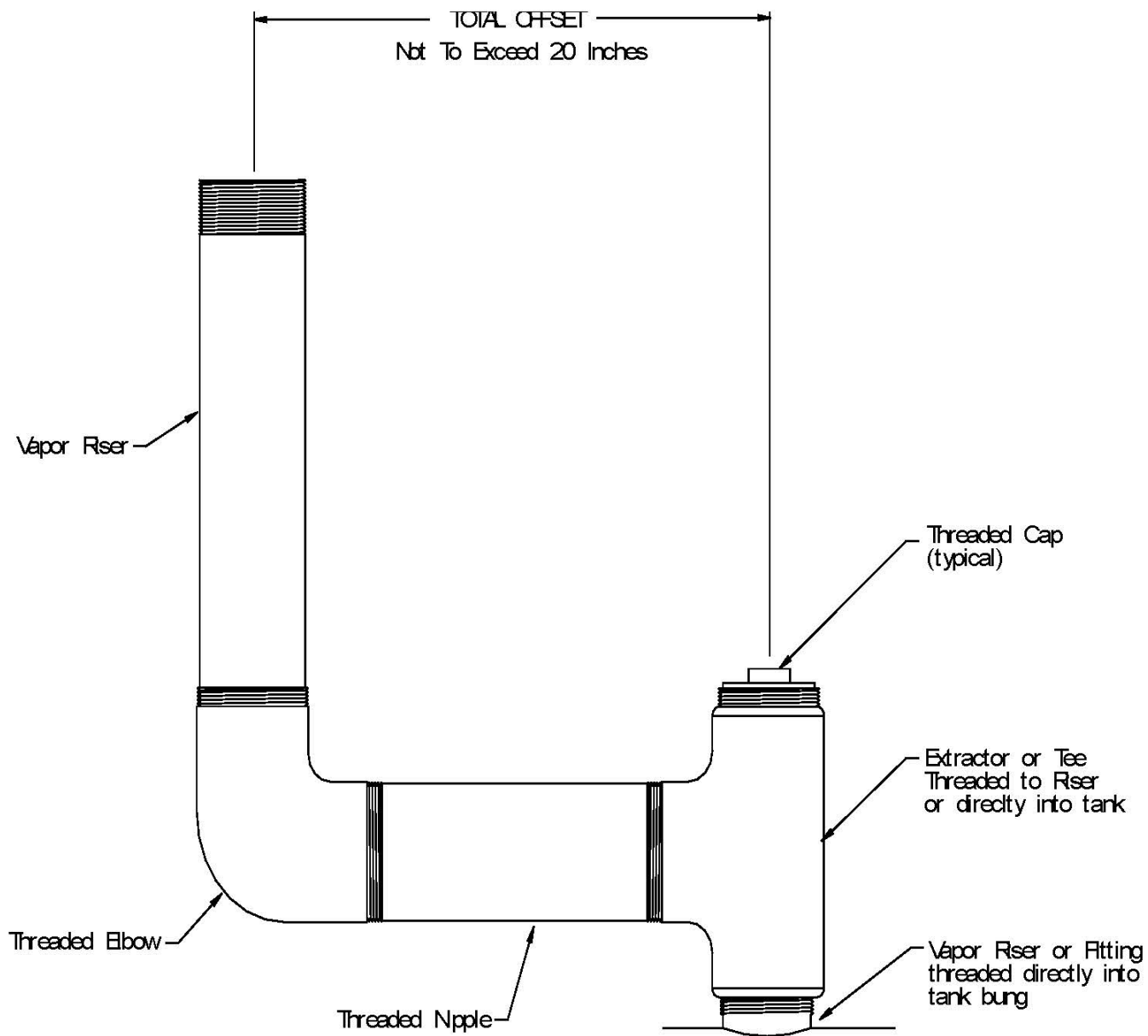

**Figure 2-8
Typical Vent Pipe Manifold**



Note: This shows only one typical configuration; other manifold configurations may be used. For example, a tee may be located in a different position, or fewer pipes may be connected, or more than one P/V valve may be installed on the manifold.

**Figure 2-9
Typical Vapor Recovery Riser Offset**



Note: This figure represents one instance where a vapor recovery riser has been offset in order to construct a two-point Phase I vapor recovery system. The above figure illustrates an offset using a 90-degree elbow. However, in some instances, elbows less than 90 degrees may be used. All fittings and pipe nipples shall be 4-inch diameter similar to those of the spill container and rotatable Phase I adaptors in order to reduce back pressure during a gasoline delivery.

Figure 2-10
Example of a GDF Phase I Maintenance Record

Date of Maintenance/ Test/Inspection/ Failure	Repair Date To Correct Test Failure	Maintenance/Test/Inspection Performed and Outcome	Affiliation	Name and Certified Technician Number of Individual Conducting Maintenance or Test	Telephone Number

Exhibit 3

Manufacturing Performance Standards and Specifications

The OPW system and all components shall be manufactured in compliance with the performance standards and specifications in CP-201, as well as the requirements specified in this Executive Order. All components shall be manufactured as certified; no change to the equipment, parts, design, materials, or manufacturing process shall be made unless approved in writing by the Executive Officer or Executive Officer Delegate. Unless specified in Exhibit 2 or in the CARB-Approved Installation, Operation, and Maintenance Manual for the OPW Phase I Vapor Recovery System, the requirements of this section apply to the manufacturing process and are not appropriate for determining the compliance status of a GDF.

Pressure/Vacuum Vent Valves for Storage Tank Vent Pipes

1. Each pressure/vacuum vent valve (P/V valve) shall be tested at the factory for cracking pressure and leak rate at each specified pressure setting when tested in accordance with **TP-201.1E, *Leak Rate and Cracking Pressure of Pressure/Vacuum Vent Valves*** (October 8, 2003).
2. Each P/V valve shall be shipped with a card or label stating the performance specifications listed in table 3-1, and a statement that the valve was tested to, and met, these specifications.
3. Each P/V valve shall have permanently affixed to it a yellow, gold, or white label with black lettering listing the positive and negative pressure settings and leak rate standards listed in Table 3-1. The lettering of the positive and negative pressure settings and leak rate standards on the label shall have a minimum font size of 20.

Rotatable Product and Vapor Recovery Adaptors

1. The rotatable product and vapor recovery adaptors shall not leak.
2. The product adaptor cam and groove shall be manufactured in accordance with the cam and groove specifications shown in Figure 3A of CP-201.
3. The vapor recovery adaptor cam and groove shall be manufactured in accordance with the cam and groove specifications shown in Figure 3B of CP-201.
4. Each product and vapor recovery adaptor shall be tested at the factory to, and met, the specifications listed in Table 3-1 and shall have affixed to it a card or label listing these performance specifications and a statement that the adaptor was tested to, and met, such specifications.

Spill Container and Drain Valves

Each Spill Container Drain Valve shall be tested at the factory to, and met, the specification listed in Table 3-1 and shall have affixed to it a card or label listing the performance specification and a statement that the valve was tested to, and met, such performance specification.

Drop Tube Overfill Prevention Device

Each Drop Tube Overfill Prevention Device shall be tested at the factory to, and met, the specification listed in Table 3-1 and shall have affixed to it a card or label listing the performance specification and a statement that the device was tested to, and met, such performance specification.

**Table 3-1
Manufacturing Component Standards and Specifications**

Component	Test Method	Standard or Specification
Rotatable Phase I Adaptors	TP-201.1B	Minimum, 360-degree rotation Maximum, 108 pound-inch average static torque
Rotatable Phase I Adaptors	Micrometer	Cam and Groove Specifications (CP-201)
Overfill Prevention Device	TP-201.1D	≤0.17 CFH at 2.00 inches H ₂ O
Spill Container Drain Valve	TP-201.1C or TP-201.1D	≤0.17 CFH at 2.00 inches H ₂ O
Pressure/Vacuum Vent Valve	TP-201.1E	Positive Pressure: 2.5 to 6.0 inches H ₂ O Negative Pressure: 6.0 to 10.0 inches H ₂ O Leak rate: ≤ 0.05 CFH at +2.0 inches H ₂ O Leak rate: ≤ 0.21 CFH at -4.0 inches H ₂ O

EXHIBIT 4

Manufacturer Warranties

This exhibit includes the manufacturer warranties for all components listed in Exhibit 1, including replacement parts and subparts. The manufacturer warranty tag, included with each component, shall be provided to the service station owner/operator at the time of installation.

Franklin Fueling Systems Warranty Statement and Tag

Franklin Fueling Systems (FFS) Enhanced Vapor Recovery (EVR) products are offered for sale under the brand names of Healy, INCON, Phil-Tite, EBW, and Franklin Fueling Systems (collectively referred to as "FFS EVR products"). FFS EVR products are fully tested at the time of manufacture to meet the applicable performance standards and specifications to which it was certified by the California Air Resource Board (CARB) for the duration of the warranty period, as indicated in the related CARB Executive Order (EO). Performance standards and specifications are listed in Exhibit 2 (System/Compliance Specifications) and Exhibit 3 (Manufacturing Performance Standards) in the related CARB EO.

FFS warrants that FFS EVR products installed in California will conform to the warranty terms and conditions required by the California Certification Procedure for Vapor Recovery Systems at Gasoline Dispensing Facilities (CP-201) with respect to (a) transferability of warranties for FFS EVR products, (b) design changes to FFS EVR products, (c) performance specifications of the FFS EVR products, and (d) duration of the warranty period of FFS EVR products.

FFS EVR products are warranted to the initial purchaser, and any subsequent purchaser within the warranty period, for workmanship, performance, and materials when properly installed, used and maintained in accordance with the CARB Approved Installation, Operation, and Maintenance Manuals by certified technicians or an owner/operator as defined in the related CARB EO and to generally accepted industry standards.

FFS reserves the right to make changes in the design or to make additions or improvements with respect to FFS EVR products without incurring any obligation to modify or install same on previously manufactured products, upon written approval from CARB.

FFS reserves the right to change or cancel all or any part of this limited warranty, upon written approval from CARB. Any such change or cancellation will be effective for products sold by FFS after the date of such change or cancellation. No agents, distributors, dealers, or employees of FFS are authorized to make modifications to this warranty or to make additional warranties with respect to any FFS EVR products. Accordingly, any statements made by individuals, whether oral or written, shall not constitute a warranty of FFS and shall not be relied upon.

FFS warrants the workmanship and materials of FFS EVR products to be free of defects, at the time of sale by FFS, for a period of one year (12 months) from the date of installation. When warranty for FFS EVR products cannot be verified to date of installation, claims will be honored for a period of fifteen (15) months from the date of purchase. When warranty for FFS EVR product cannot be verified to date of installation or date of purchase, claims will be honored for a period of eighteen (18) months from date of manufacture by FFS (for location of date of manufacture on components, see related CARB EO Exhibit 1 – Equipment List). In all cases, installation date or purchase date will require providing formal documentation to FFS as evidence

of applicable warranty coverage or date of manufacture will be used to determine duration of warranty period. Formal documentation may include, but is not limited to, FFS authorized service company and distributor work orders, startup/installation documentation, maintenance logs, and/or sales receipts.

FFS shall not be liable for any loss or damage whatsoever, including, without limitation, loss in profits, loss in sales, loss of fuel or other products, loss of use of equipment, facilities or service, costs of environmental remediation, diminution in property value, or any other special, incidental or consequential damages of any type or nature, and all such losses or damages are hereby disclaimed and excluded from this limited warranty.

Use of non-FFS replacement parts, the unauthorized addition of non-FFS items to FFS EVR products, and the unauthorized alteration of FFS EVR products will void warranty. FFS shall, as to each defect, be relieved of all obligations and liabilities under a components warranty if the FFS EVR products have been operated with any accessory, equipment, or a part not specifically approved by FFS and not manufactured by FFS to FFS design and specifications.

FFS EVR product warranty shall not apply to any products which have been mishandled, incorrectly installed or applied, altered in any way, which has been repaired by any party other than qualified technicians, or when such failure is due to misuse or conditions of use (such as, but not limited to, blown fuses, sheared breakaway screws, corrosion damage, negligence, accidents, or normal wear of plastic/rubber parts including scuff guards and seals). FFS EVR product warranty shall not apply to acts of terrorism, acts of war, or acts of God (such as, but not limited to, fire, flood, earthquake, or explosion). Unless otherwise expressly provided in a specific FFS written warranty, FFS does not provide coverage for labor or shipping charges, shall not be liable for any costs or charges attributable to any product testing, maintenance, installation, repair or removal, or any tools, supplies, or equipment need to install, repair, or remove any FFS EVR product.

Other than those FFS EVR products specifically designated for fuel concentrations of 85% ethanol with 15% gasoline (E85), FFS EVR product warranty shall not cover any components that have been in contact with fuel concentrations greater than 15% ethanol or 15% methanol by volume (up to E15/M15).

Claims for FFS EVR product warranty must be submitted in writing promptly after discovery of a defect with a Returned Goods Authorization (RGA) Number from FFS. FFS will honor warranty claims processed through FFS authorized service companies and distributors only. FFS will honor warranty claims submitted no more than thirty (30) days after the end of the applicable warranty period. Product returned for warranty inspection must be shipped freight prepaid to FFS's facilities, with the RGA Number indicated on the returned product, to the following address for inspection:

INCON branded products:
Franklin Fueling Systems, Inc.
ATTN: Warranty Department
34 Spring Hill Road
Saco, ME 04072 USA

All other FFS EVR Products:
Franklin Fueling Systems, Inc.
ATTN: Warranty Department
3760 Marsh Road
Madison, WI 53718 USA

Franklin Fueling Systems, upon inspection and after determination of a warranty defect, will at its option, repair or replace defective parts returned to FFS's facility or where the product is in use. Repaired or replaced parts will be returned freight prepaid by FFS.

A copy of this limited warranty is to be retained with the equipment, on-site with the facility owner/operator.

Component Model Number : _____
Component Date of Manufacturer : _____
Component Install Date : _____
Facility Name : _____
Facility Address : _____
Installer Name : _____
Installer Signature : _____

Morrison Bros. Co. Warranty Statement and Tag

WARRANTY— All Morrison products are thoroughly tested before shipment and meet all applicable performance standards and specifications of related ARB executive orders and vapor recovery procedures of CP-206 (Certification Procedure for Vapor Recovery Systems at Gasoline Dispensing Facilities Using Aboveground Storage Tanks) or CP-201 (Certification Procedure for Vapor Recovery Systems at Dispensing Facilities). This warranty shall include the ongoing compliance with all applicable performance standards and specifications for the duration of the warranty. Only material found to be defective in manufacture will be repaired or replaced. Claims must be made within one year from the date of installation, and Morrison Bros. Co. will not allow claims for labor or consequential damage resulting from purchase, installation or misapplication of the product. This warranty will include the initial purchaser and any subsequent purchasers of the initial equipment within the warranty period. This warranty registration must remain with the equipment and be provided to the end user. If a warranty claim needs to be pursued, a copy of this information and the invoice of these products to the purchaser must be supplied to Morrison for verification.

Installation Date: _____
Name Of Installer/Contractor _____
Installation Company: Name _____
Address _____
City _____ State _____ Zip _____
Business At Installation Site: Name _____
Address _____
City _____ State _____ Zip _____
Morrison Product(s) I.D Numbers With Date Of Manufacture _____

Date of manufacture can be found on the product identification label applied to the finished product. This warranty registration must remain with the equipment and be provided to the end user. If a warranty claim needs to be pursued, a copy of this information and the invoice of these products to the purchaser must be supplied to Morrison for verification.

OPW STANDARD PRODUCT WARRANTY TAG

Notice: FlexWorks by OPW, Inc., VAPORSAVER™ and all other OPW products must be used in compliance with all applicable federal, state, provincial and local laws, rules and regulations. Product selection is the sole responsibility of the customer and/or its agents and must be based on physical specifications and limitations, compatibility with the environment and material to be handled. All illustrations and specifications in this literature are based on the latest production information available at the time of publication. Prices, materials and specifications are subject to change at any time, and models may be discontinued at any time, in either case, without notice or obligation.

OPW warrants solely to its customer (the initial purchaser and any subsequent purchasers within the warranty period) that the following products sold by OPW will be free from defects in materials and workmanship under normal use and conditions for the periods indicated:

PRODUCT	WARRANTY PERIOD
FlexWorks Primary Pipe	10 years from date of manufacture
All Products and replacement parts installed in the State of California Certified to California CP-201 and/or CP-206 Standards*	1 year from-date of installation (proof of purchase from certified contractors/technicians required) OPW warrants ongoing compliance with the standards and specifications for the duration of the warranty period required by the State of California; this limited warranty is under the condition the equipment was installed and maintained by trained and certified contractors/technicians unless noted in Installation Manual
All other Products and replacement parts	1 year from date of manufacture**
*Products certified to California CP-201 and/or CP-206 Standards have been factory tested and met all applicable performance standards and specifications and will have an OPW registration card enclosed/attached to the product	

OPW's exclusive obligation under this limited warranty is, at its option, to repair, replace or issue credit (in an amount not to exceed the list price for the product) for future orders for any product that may prove defective within the applicable warranty period. (Parts repaired or replaced under warranty are subject to prorated warranty coverage for remainder of the original warranty period). Complete and proper warranty claim documentation and proof of purchase required. All warranty claims must be made in writing and delivered during the applicable warranty period to OPW at OPW 9393 Princeton-Glendale Road Hamilton, Ohio, USA 45011, Attention: Customer Service Manager. No products may be returned to OPW without its prior written authority.

This limited warranty shall not apply to any FlexWorks or VAPORSAVER™ product unless it is installed by an OPW attested installer and all required site and warranty registration forms are completed and received by OPW within 60 days of installation. This limited warranty also shall not apply to any FlexWorks, VAPORSAVER™ or other OPW product: unless all piping connections are installed with a nationally-recognized or state-approved leak detection device in each tank and dispenser sump (which are not for storage and from which all discharge hydrocarbons must be removed, and the systems completely cleaned, within 24 hours); unless testable sumps utilize FlexWorks pipe and access fittings; unless a sump inspection log or an

EPA recommended/required checklist is maintained and the results are furnished to OPW upon request; and unless OPW is notified within 24 hours of any known or suspected product failure and is provided with unrestricted access to the product and the site. This limited warranty also shall not apply to any product which has been altered in any way, which has been repaired by anyone other than a service representative authorized by OPW, or when failure or defect is due to: improper installation or maintenance (including, without limitation, failure to follow FlexWorks Quick Reference Manual Installation Guide and all product warning labels); abuse or misuse; violation of health or safety requirements; use of another manufacturer's, or otherwise unauthorized, substances or components; soil or other surface or subsurface conditions; or fire, flood, storm, lightning, earthquake, accident or any other conditions, events or circumstances beyond OPW's control.

THIS LIMITED WARRANTY IS IN LIEU OF ALL OTHER WARRANTIES, EXPRESS OR IMPLIED, AND ALL OTHER WARRANTIES INCLUDING, WITHOUT LIMITATION, THE WARRANTIES OF MERCHANTABILITY AND FITNESS FOR A PARTICULAR PURPOSE, ARE HEREBY EXCLUDED.

OPW shall have no other liability whatsoever, whether based on breach of contract, negligence, gross negligence, strict liability or any other claim, including, without limitation, for special, incidental, consequential or exemplary damages or for the cost of labor, freight, excavation, clean-up, downtime, removal, reinstallation, loss of profit, or any other cost or charges. No person or entity is authorized to assume on behalf of OPW any liability beyond this limited warranty. This limited warranty is not assignable.

** Date of manufacture on this product is located (*location will be specific to each component*)



North America Toll Free - TELEPHONE: (800)
422-2525 - Fax: (800) 421-3297 - Email:
domesticsales@opw-fc.com

9393 Princeton-Glendale
Road
Hamilton, Ohio 45011

International – TELEPHONE: (513) 870-3315
or (513) 870-3261 - Fax: (513)
870-3157 - Email: intlsales@opw-fc.com
www.opwglobal.com

Comp X TANK Commander Warranty Statement and Tag

Seller warrants to the initial and subsequent purchasers, for a period of one year from date of installation, that the Products sold hereunder will, at the time of delivery: (a) comply with the ARB CP-201 standards and specifications for the duration of the warranty period for such Products in effect at the time of shipment or such other specifications as are expressly agreed upon by Seller and Buyer in writing; (b) be adequately contained, packaged, and labeled; and (c) conform to any promises and affirmations of fact made on the container and label. In the event that any such Products fail to conform to the foregoing warranty, Seller will, at its option, repair or replace such nonconforming Products, or credit Buyer for an amount not to exceed the original sales price of such Products. Shipping costs incurred in returning such nonconforming Products to Seller shall be borne by Seller, but Seller shall in no event be liable for any inspection, handling, or packaging costs incurred by Buyer in connection with such Products. Buyer's negligence, misuse, improper installation, or unauthorized repair or alteration, shall void this warranty. The TANK Commander Warranty tag is located on the inside cover of the product.

Warranty Tag

TANK Commander TC-1

1 year warranty from date of installation

Date of manufacture __/__/----

The CompX TANK Commander product was factory tested and meets the standards and specifications to which it was certified by the California Air Resources Board (CARB) as indicated in the related CARB Phase I EVR Executive Orders.

Husky Corporation Warranty Statement and Tag

VAPOR PRODUCTS – Husky Corporation will, at its option, repair, replace, or credit the purchase price of any Husky manufactured product which proves upon examination by Husky, to be defective in material and/or workmanship for a period of one (1) year of installation or fifteen (15) months from the manufacture date of shipment by Husky, whichever occurs first. The warranty period on repaired or replacement vapor recovery products is only for the remainder of the warranty period of the defective product.

EVR PRODUCTS – With respect to EVR products installed in California, for a period of one (1) year from the date of installation, Husky warrants that the product will be free from defects in materials and workmanship (if the installation date is in question or indeterminable, Husky will warrant the product for 12 months from sale by Husky). Husky confirms that the warranty is transferable to a subsequent purchaser within the warranty period. However, the warranty does not follow the product from its initial installation location to succeeding locations. Husky confirms these products are warranted to meet the performance standards and specifications to which it was certified by CARB for the duration of the warranty. EVR products must be installed per CARB Executive Order and must follow the Husky Installation Instructions or the warranty is void. The warranty tag included with the EVR product must be provided to the end user at installation. A completed warranty tag and installation documentation is required to be returned with the product to be eligible for warranty consideration.

CONVENTIONAL PRODUCTS – Husky Corporation will, at its option, repair, replace, or credit the purchase price of any Husky manufactured product which proves upon examination by Husky, to be defective in material and/or workmanship for a period of one (1) year from the manufacture date of shipment by Husky.

Buyer must return the products to Husky, transportation charges prepaid. This Warranty excludes the replaceable bellows, bellows spring assembly, spout assembly and scuff guard, unless (i) damage is obvious when the product is removed from shipping carton and (ii) the defective product is returned to Husky prior to use. This warranty does not apply to equipment or parts which have been installed improperly, damaged by misuse, improper operation or maintenance, or which are altered or repaired in any way.

The warranty provisions contained herein apply only to original purchasers who use the equipment for commercial or industrial purposes. There are no other warranties of merchantability, fitness for a particular purpose, or otherwise, and any other such warranties are hereby specifically disclaimed.

Husky assumes no liability for labor charges or other costs incurred by Buyer incidental to the service, adjustment, repair, return, removal or replacement of products. Husky assumes no liability for any incidental, consequential, or other damages under any warranty, express or implied, and all such liability is hereby expressly excluded.

Husky reserves the right to change or improve the design of any Husky fuel dispensing equipment without assuming any obligations to modify any fuel dispensing equipment previously manufactured.



*** WARRANTY TAG**

Husky Corporation
2325 Husky Way
Pacific, Mo 63069
(800) 325-3558

**Husky
General Fueling Products:**

Station Name: _____

Model #: _____

Store #: _____ Date: _____

Serial #: _____

City: _____ State: _____

Installation Date: _____

Service Contractor: _____

Manufacturer Lot #: _____

Service Tech: _____

Work order # (if applicable): _____

Distributor: _____

RGA #: _____

No warranty accepted without warranty tag filled out completely and attached to product.

Form #009179-6 03/2013

FRONT VIEW

FOR REFERENCE ONLY

Reason for Return (check all applicable):

Leaking Fuel Around Spout

Failed Pressure Decay Test

Leaking Fuel In Trigger Area

Leaking Fuel at Hose Inlet

Keeps Shutting Off

Mechanical Malfunction

Will Not Shut Off

Dispenses Fuel Without Pulling Lever

Notes / Comments: _____

EVR products installed in California are warranted for 1 year from the date of installation. Manufacturing data can be found on the product data tag attached to the product. Husky confirms the product was tested at the factory and met all applicable performance standards in CP-201 including Pressure Setting: 2.5-6.0 in W.C., Vacuum Setting: 6.0 - 10.0 in W.C. and Leak Rate: 0.05 CFH @ +2.0 in W.C. and 0.21 CFH @ -4.0 in W.C. Please provide installation documentation such as a purchase order, an invoice or a receipt at time of claim.

BACK VIEW

Veeder-Root Warranty Statement and Tag

This warranty applies only when the product is installed in accordance with Veeder-Root's specifications. This warranty will not apply to any product which has been subjected to misuse, negligence, accidents, systems that are misapplied or are not installed per Veeder-Root specifications, modified or repaired by unauthorized persons, or damage related to acts of God. Veeder-Root is not liable for incidental, consequential, or indirect damages or loss, including, without limitation, personal injury, death, property damage, environmental damages, cost of labor, clean-up, downtime, installation and removal, product damages, loss of product, or loss of revenue or profits. This warranty applies to the initial purchaser and any subsequent purchaser for the duration of the warranty period. **THE WARRANTY CONTAINED HEREIN IS EXCLUSIVE AND THERE ARE NO OTHER EXPRESS, IMPLIED, OR STATUTORY WARRANTIES. WARRANTIES OF MERCHANTABILITY OR FITNESS FOR A PARTICULAR PURPOSE ARE EXPRESSLY EXCLUDED.**

CAP AND RING ADAPTOR

We warrant that this product shall be free from defects in material and workmanship and is compliant with all applicable performance standards and specifications for which it has been certified, for a period of one (1) year from the date of installation. During the warranty period, we or our representative will repair or replace the product, if determined by us to be defective, at the location where the product is in use and at no charge to the purchaser.

Warranty Card Language

EQUIPMENT WARRANTY

Veeder-Root warrants that this product shall be free from defects in material and workmanship and is compliant with all applicable performance standards and specifications for which it has been certified, for a period of one (1) year from date of installation.

Date of manufacture:

This component was tested at the time of manufacture and meets all the applicable performance standards and specification to which it was certified: EO VR-101 and EO VR-102.

For detailed warranty terms see EO VR101 or EO VR-102 warranty exhibits on the ARB Web site at <http://www.arb.ca.gov/vapor/eo-evrphase1.htm>

McGard Warranty Statement and Tag

McGard Fuel Locks are fully tested at the time of manufacture to meet the applicable performance standards and specifications to which it was certified by the California Air Resource Board (CARB) for the duration of the warranty period, as indicated in the related CARB Executive Order (EO). Performance standards and specifications are listed in Exhibit 2 (System/Compliance Specifications) and Exhibit 3 (Manufacturing Performance Standards) in the related CARB EO.

McGard warrants that McGard Fuel Lock products installed in California will conform to the warranty terms and conditions required by the California Certification Procedure for Vapor Recovery Systems at Gasoline Dispensing Facilities (CP-201) with respect to (a) transferability of warranties for McGard Fuel Locks, (b) design changes to McGard Fuel Locks, (c) performance specifications of the McGard Fuel Locks, and (d) duration of the warranty period of McGard Fuel Locks.

McGard Fuel Locks are warranted to the initial purchaser, and any subsequent purchaser within the warranty period, for workmanship, performance, and materials when properly installed, used and maintained in accordance with the CARB Approved Installation, Operation, and Maintenance Manuals by certified technicians as defined in the related CARB EO and to generally accepted industry standards.

McGard reserves the right to make changes in the design or to make additions or improvements with respect to McGard Fuel Locks without incurring any obligation to modify or install same on previously manufactured products, upon written approval from CARB.

McGard reserves the right to change or cancel all or any part of this limited warranty, upon written approval from CARB. Any such change or cancellation will be effective for products sold by McGard after the date of such change or cancellation. No agents, distributors, dealers, or employees of McGard are authorized to make modifications to this warranty or to make additional warranties with respect to any McGard Fuel Locks. Accordingly, any statements made by individuals, whether oral or written, shall not constitute a warranty of McGard and shall not be relied upon.

McGard warrants the workmanship and materials of McGard Fuel Locks to be free of defects, at the time of sale by McGard, for a period of one year (12 months) from the date of installation. When warranty for McGard Fuel Locks cannot be verified to date of installation, claims will be honored for a period of fifteen (15) months from the date of purchase. When warranty for McGard Fuel Locks cannot be verified to date of installation or date of purchase, claims will be honored for a period of eighteen (18) months from date of manufacture by McGard (date of manufacture is engraved on side of lock body). In all cases, installation date or purchase date will require providing formal documentation to McGard as evidence of applicable warranty coverage or date of manufacture will be used to determine duration of warranty period. Formal documentation may include, but is not limited to McGard authorized service company and distributor work orders, startup/installation documentation, maintenance logs, and/or sales receipts.

McGard shall not be liable for any loss or damage whatsoever, including, without limitation, loss in profits, loss in sales, loss of fuel or other products, loss of use of equipment, facilities or service, costs of environmental remediation, diminution in property value, or any other special,

incidental or consequential damages of any type or nature, and all such losses or damages are hereby disclaimed and excluded from this limited warranty.

Use of non-McGard replacement parts, the unauthorized addition of non-McGard items to McGard Fuel Locks, and the unauthorized alteration of McGard Fuel Locks will void warranty. McGard shall, as to each defect, be relieved of all obligations and liabilities under a components warranty if the McGard Fuel Locks have been operated with any accessory, equipment, or a part not specifically approved by McGard and not manufactured by McGard to McGard design and specifications.

McGard Fuel Lock warranty shall not apply to any products which have been mishandled, incorrectly installed or applied, altered in any way, which has been repaired by any party other than qualified technicians, or when such failure is due to misuse or conditions of use (such as, but not limited to, blown fuses, sheared breakaway screws, corrosion damage, negligence, accidents, or normal wear of plastic/rubber parts including scuff guards and seals). McGard Fuel Lock warranty shall not apply to vandalism, theft, acts of terrorism, acts of war, or acts of God (such as, but not limited to, fire, flood, earthquake, or explosion). Unless otherwise expressly provided in a specific McGard written warranty, McGard does not provide coverage for labor or shipping charges, shall not be liable for any costs or charges attributable to any product testing, maintenance, installation, repair or removal, or any tools, supplies, or equipment need to install, repair, or remove any McGard Fuel Lock.

Other than those McGard Fuel Locks specifically designated for fuel concentrations of 85% ethanol with 15% gasoline (E85), McGard Fuel Lock product warranty shall not cover any components that have been in contact with fuel concentrations greater than 15% ethanol or 15% methanol by volume (up to E15/M15).

Claims for McGard Fuel Lock warranty must be submitted in writing promptly after discovery of a defect with a Returned Goods Authorization (RGA) Number from McGard. McGard will honor warranty claims processed through McGard authorized service companies and distributors only. McGard will honor warranty claims submitted no more than thirty (30) days after the end of the applicable warranty period. Product returned for warranty inspection must be shipped freight prepaid to McGard's facilities, with the RGA Number indicated on the returned product, to the following address for inspection:

McGard LLC, ATTN: Warranty Department, 3875 California Road, Orchard Park, NY 14127 USA

McGard, upon inspection and after determination of a warranty defect, will at its option, repair or replace defective parts returned to McGard's facility or where the product is in use. Repaired or replaced parts will be returned freight prepaid by McGard.

A copy of this limited warranty is to be retained with the equipment, on-site with the facility owner/operator.

Component Model Number:

Component Date of Manufacturer:

Component Install Date:

Facility Name:

Facility Address:

Installer Name:

Installer Signature:

Exhibit 5

VAULTED ABOVEGROUND STORAGE TANK CONFIGURATION (Optional)

This exhibit allows an alternate tank storage configuration for the Phase I EVR system. A vaulted aboveground storage tank (AST) may be installed in substitute for a conventional underground storage tank (UST). The figures in this exhibit provide examples of typical vaulted AST configurations.

General Specifications

1. Alternate typical vaulted AST configurations for the Phase I EVR Systems are shown in Figures 5-1, 5-2, 5-3, and 5-4.
2. Unless otherwise specified in this Executive Order (EO), the vaulted AST configuration shall comply with the applicable performance standards and performance specifications in CP-201. The emergency vent shall be a certified vent listed in the Phase I EVR Executive Orders for ASTs and shall be installed, operated, maintained and meet any performance requirements specified in the applicable AST Executive Order.

Figure 5-1: Front Sectional Views of Typical Vaulted AST

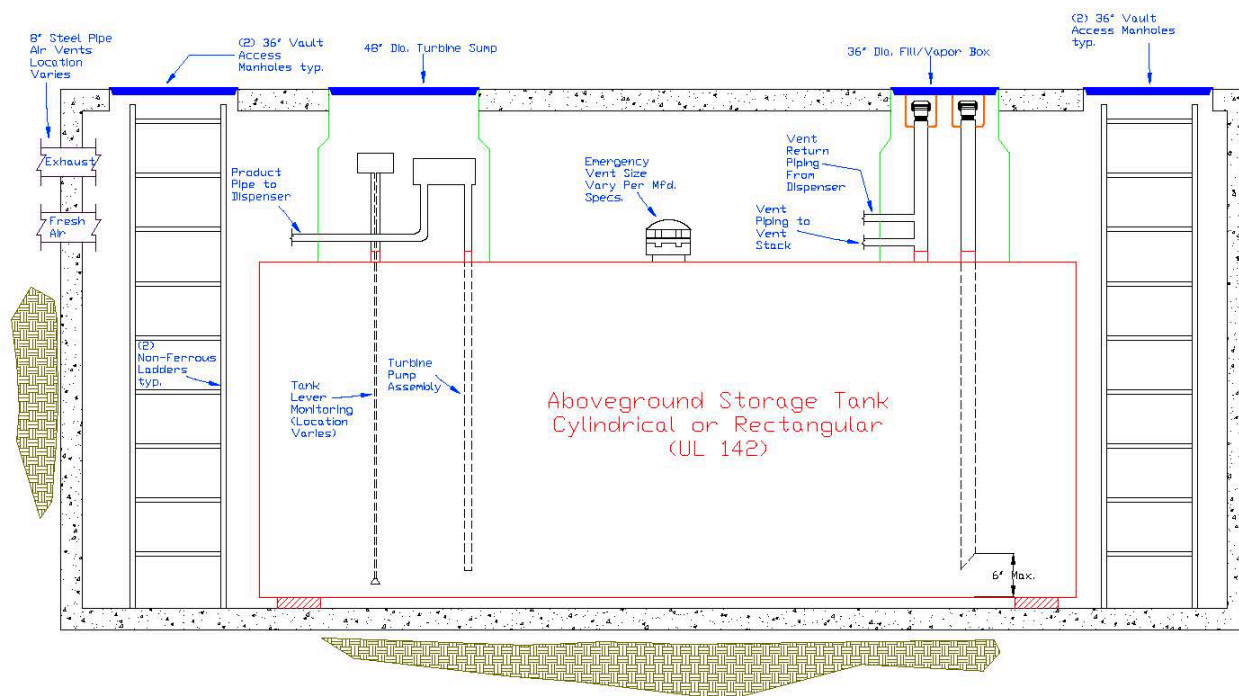

Figure 5-2: Top Sectional View of Typical Vaulted AST

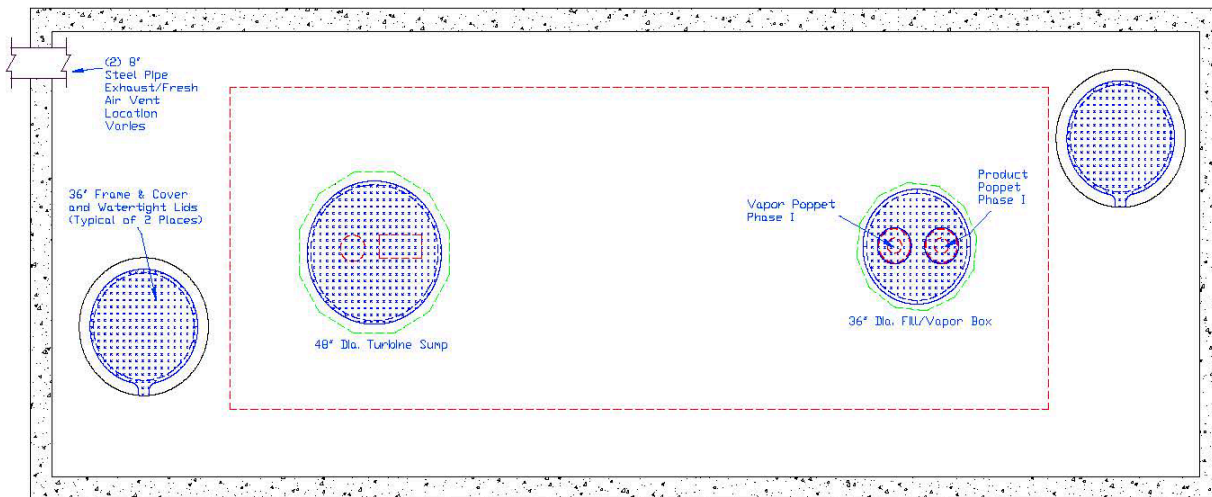

Figure 5-3: End Sectional View of Typical Vaulted AST

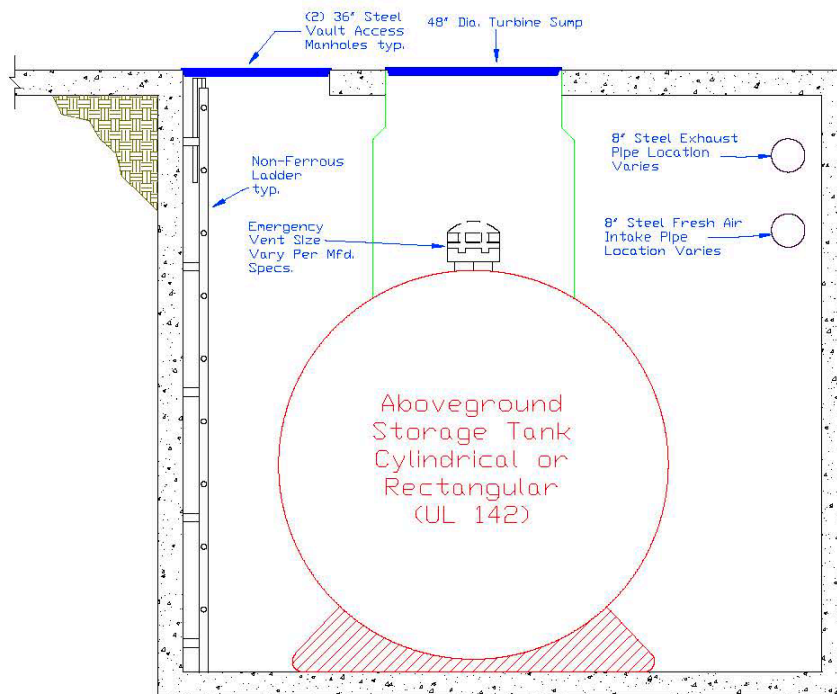

Figure 5-4: Sectional Views of Typical Vaulted AST (Ventilation

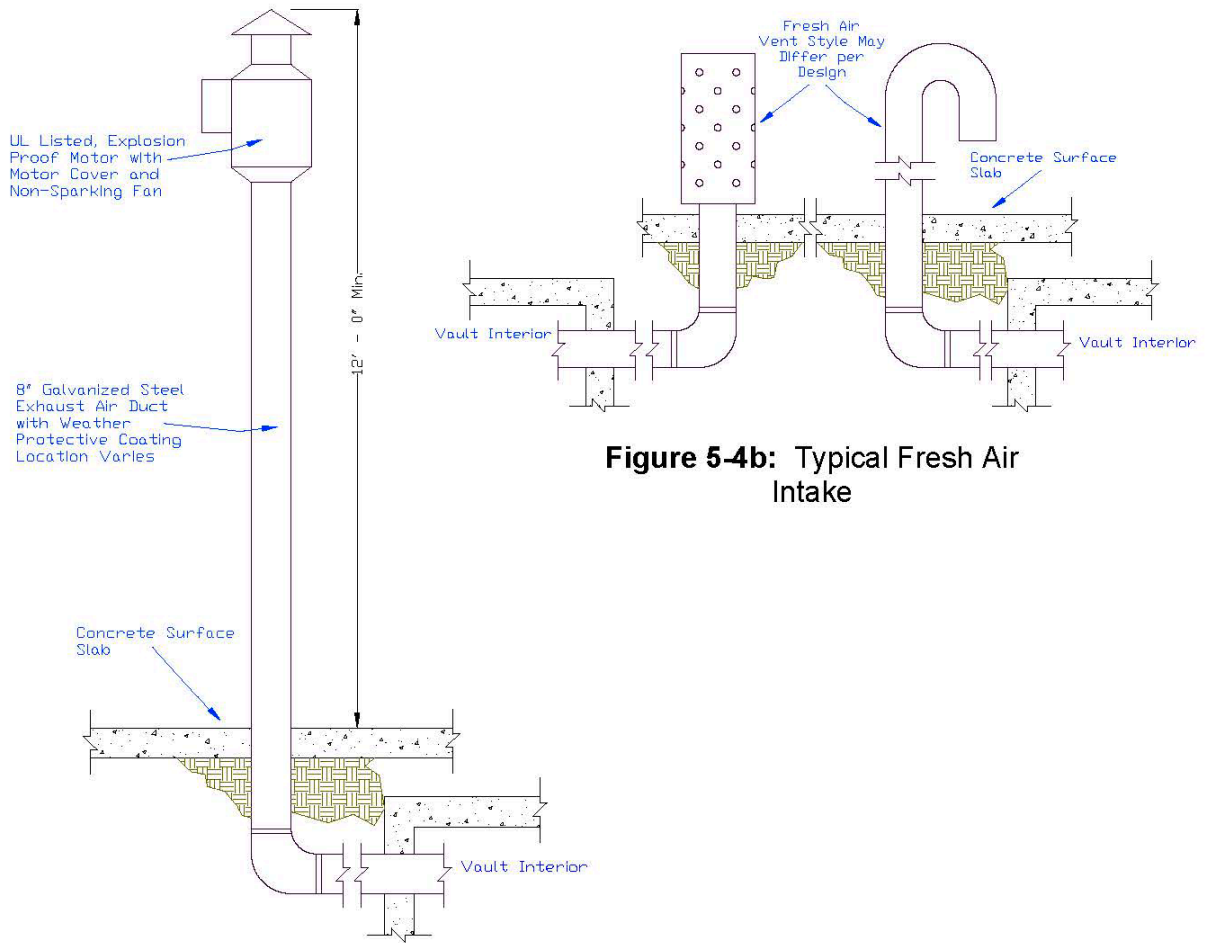

Figure 5-4a: Typical Exhaust

**Executive Order VR-102-S
Assist Phase I EVR Systems**

EXHIBIT 6

Required Items for Conducting TP-201.1C/TP-201.D on a Remote Fill System

Applicability

Exhibit 6 applies to CARB certified Phase I Remote Fill System (RFS), where the secondary product and vapor return pathway and adaptors are located in an alternate sump approximately 120 feet away from the primary product and vapor risers installed directly on top of the underground storage tanks (UST). This exhibit shall apply only to RMS with a length no greater than 200 feet. For RMS greater than 200 feet, an application shall be submitted to CARB Executive Officer for evaluation. The application shall contain applicable information requested in Section 18 of the Certification Procedures for Vapor Recovery Systems at Gasoline Dispensing Facilities (CP-201).

Existing Test Procedures

Sections 7.3 of TP-201.1C and section 7.5 of TP-201-1D require adjusting the nitrogen flow rate to maintain a pressure of 2.0 inches water column (WC) with a flow rate no greater than the allowable leak rate specified in CP-201. If the pressure (±0.05 inches H₂O) cannot be maintained for at least five minutes, the system has a leak. This procedure works well when the product fill is directly above the UST for some RFS with vapor and product return lines less than 50 feet.

Procedure for Testing Remote Fill System

The TP.201.1D pressure up standard of five minutes may not be appropriate for RFS with lengths greater than 50 feet, since pressurizing the system to 2.0 inches WC may take longer than five minutes. The following steps shall be taken when conducting TP-201.1C or TP-201.1D on RFS that has a secondary product and vapor return pathway and adaptors located greater than 50 feet away. The following information shall be submitted to Districts as part of a compliance test. Districts may require the use of an alternate form to meet these requirements, but that form shall include, at a minimum contain the information listed below

Required Steps	Verification (please circle)
Is the remote fill product adaptor less than 50 feet away from the top of the UST? If so, the maximum pressure up time shall be less than 5 minutes.	<u>Yes No</u>
Is the remote fill pipe lengths greater than 50 feet but less than 200 feet? See Table 1 for pressure up time.	<u>Yes No</u>

Test Company: _____ Facility Name: _____

Print Name (Technician) _____ Signature _____ Date _____

Technician Certification Number and Expiration Date
(ICC or District Training Certification, as applicable)

Table 1
Time to Pressurize GDF Equipped with Remote Fill Pipe Configuration by Length

<u>Horizontal Length of Remote Fill Pipe (feet)</u>	<u>Time to Pressurize (minutes)</u>
<u>≤50</u>	<u>5</u>
<u>>50, ≤100</u>	<u>10</u>
<u>>100, ≤150</u>	<u>15</u>
<u>>150, <200</u>	<u>20</u>
<u><200, <250</u>	<u>25</u>